

PIAZZA

CATALOGO CATALOGUE
2026 2027



LEGENDA CATALOGO

CATALOGUE KEY



Quando la singola confezione contiene più pezzi è presente questo simbolo
When the single pack contains more pieces there is this symbol

Beccuccio versatore
"Versus"
"Versus" pouring spout

Cod.	Col.	Box
50100112		4
50100312		4
50100412		4
50100612		4

CONFEZIONAMENTO DEL PRODOTTO PRODUCT PACKAGING	CODICE PRODOTTO ITEM NUMBER	INFO PRODOTTO Dimensioni, colore, capacità, ecc. PRODUCT INFO Sizes, colour, capacity, etc.	MULTIPLIO DI VENDITA Se non indicato si intende un pezzo singolo BOX QUANTITY If not stated just one piece

SIMBOLI CONFEZIONAMENTO PRODOTTI PRODUCTS PACKAGING SYMBOLS

 SCATOLA BOX	 SCATOLA APPENDIBILE HANGING BOX	 SACCHETTO BAG	 SACCHETTO APPENDIBILE HANGING BAG
 CARTONCINO APPENDIBILE HANGING CARD	 BLISTER SKINPACK	 TERMORETRAIBILE SHRINK WRAP	 VARIABLE VARIABLE

SIMBOLI UTILIZZO PENTOLAME POTS AND PANS SYMBOLS

 GAS	 VETROCERAMICA CERAMIC	 ELETTRICO HOTPLATES	 INDUZIONE INDUCTION
---------	------------------------------	----------------------------	----------------------------

I MATERIALI THE MATERIALS

Acciaio inox	Stainless steel	Stahl	Inox	Inox
Alluminio	Aluminum	Aluminium	Aluminium	Aluminio
Alluminio anodizzato	Anodized aluminum	Aluminium anodisiert	Alu anodisé	Aluminio anodizado
Alluminio oxalizzato	Oxalized aluminum	Aluminium eloxiert	Alu éloxé	Aluminio oxalizado
Alluminio antiaderente	Non-stick aluminum	Aluminium mit Antihafbeschichtung	Aluminium antiadhésif	Aluminio antiadherente
Alluminio pressofuso	Die-cast aluminum	Druckgussaluminium	Aluminium moulé sous pression	Aluminio fundido bajo presión
Banda stagnata	White latten	Blech	Fer étamé	Banda estañada
Caucciù	Rubber	Kautschuk	Caoutchouc naturel	Caucho
Ceramica	Ceramic	Ton	Céramique	Cerámica
Cotone	Cotton	Baumwolle	Coton	Algodón
Ferro Bianco	White Iron	Weiss eisen	Fer blanc	Hierro blanco
Ferro Blu	Blue steel	Blau Blech	Fer bleu	Hierro azul
Fibra di vetro	Fiberglass	Fiberglas	Fibre de verre	Fibra de vidrio
Gomma	Rubber	Gummi	Caoutchouc	Goma
Latta	Tin	Blech	Fer Blanc	Hojalata
Legno	Wood	Holz	Bois	Madera
Melamina	Melamin	Melamin	Mélamine	Melamina
Ottone	Brass	Messing	Laiton	Latón
Pelle ovina	Kid leather	Olivinleder	Cuir de boeuf	Piel ovina
Plastica	Plastic	Plastik	Plastique	Plástico
Poliamide	Polyamide	Polyamid	Polyamide	Poliàmida
Policarbonato	Polycarbonate	Polikarbonat	Polycarbonate	Policarbonato
Polietilene	Polyethylene	Polyäthlen	Polyéthlene	Polietileno
Polipropilene	Polypropylene	Polypropylen	Polypropylène	Polipropileno
Porcellana	Porcelain	Porzellan	Porcelaine	Porcelana
Propilene	Propylene	Propylen	Propylène	Propileno
Rame	Copper	Kupfer	Cuivre	Cobre
Resina	Resin	Harz	Résine	Resina
Silicone	Silicone	Silikon	Silicone	Silicona
Vetro	Glass	Glaz	Verre	Vidrio



PIAZZA

CATALOGO CATALOGUE 2026 2027

ACCESSORI	ACCESSORIES	11
CUCINA	COOKWARE	31
PIZZERIA		85
PASTICCERIA	PÂTISSERIE	113
TAVOLA	TABLEWARE	137
BAR		151

UNA STORIA DI QUALITÀ E DI ATTACCAMENTO AL NOSTRO TERRITORIO

HISTORY OF QUALITY AND CONNECTION WITH OUR LAND



NASCE IL NUOVO STABILIMENTO SULLO STESSO LUOGO DEL VECCHIO E INIZIA LA SPECIALIZZAZIONE NEL SETTORE HO.RE.CA.

THE NEW PLANT IS BUILT ON THE SAME SITE OF THE OLD ONE AND IT STARTS FOCUSING ON PROFESSIONAL KITCHEN TOOLS

1880



I FRATELLI GIUSEPPE E BALDASSARRE PIAZZA FONDANO L'AZIENDA

THE COMPANY WAS FOUNDED BY THE BROTHERS GIUSEPPE AND BALDASSARRE PIAZZA

1970

GIANNI PIAZZA BREVETTA IL PRIMO PORZIONATORE IN ACCIAIO INOX. È SOLO UNO DEI TANTI BREVETTI DI QUEGLI ANNI

GIANNI PIAZZA PATENTS THE FIRST ICE-CREAM SCOOP MADE OF STAINLESS STEEL. IT'S JUST ONE OF THE MANY PATENTS OF THOSE YEARS

1961

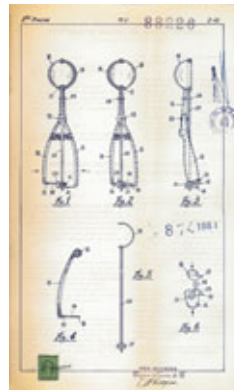

1906



DOPO POCHI ANNI DI VITA PIAZZA È GIÀ ATTIVA SUI PRIMI MERCATI DELL'ERA MODERNA

AFTER A FEW YEARS PIAZZA IS ALREADY ACTIVE ON THE FIRST MARKETS OF THE MODERN ERA

1930

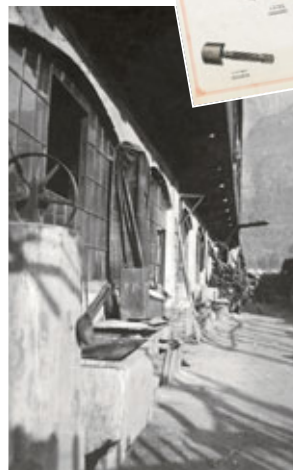

COMINCIA IL PASSAGGIO DA LABORATORIO FAMILIARE A MODERNA INDUSTRIA

THE TRANSITION FROM FAMILY WORKSHOP TO MODERN MANUFACTURING COMPANY BEGINS

ANCHE IL SECONDO STABILIMENTO DIVENTA OPERATIVO

ALSO THE SECOND PLANT GETS OPERATIONAL



2004



IL LANCIO DELLA LINEA "HAPPY HOUR" RIVOLUZIONA IL MONDO DEL BARTENDING. DAL 2006 AL 2021 PIAZZA DIVENTA SPONSOR TECNICO DI ALMA, LA SCUOLA INTERNAZIONALE DI CUCINA ITALIANA

THE LAUNCH OF THE 'HAPPY HOUR' LINE TRANSFORMS THE WORLD OF BARTENDING. FROM 2006 TO 2021 PIAZZA BECOMES TECHNICAL SPONSOR OF ALMA, THE SCHOOL OF ITALIAN CULINARY ARTS

2021



NASCE LA NUOVA COLLEZIONE PIZZERIA "PUNTOROSSO", 100% MADE IN ITALY

THE NEW PIZZERIA RANGE IS LAUNCHED ON THE MARKET. 'PUNTOROSSO' COLLECTION: 100% MADE IN ITALY

LA COLLEZIONE PIZZERIA SI AMPLIA CON LA NUOVA LINEA "BLUE DROP"

THE PIZZERIA RANGE EXPANDS WITH THE NEW 'BLUE DROP' LINE



2025

1990

OGGI PIAZZA È UN'AZIENDA PRONTA AD AFFRONTARE LE SFIDE DI UN MERCATO IN RAPIDA E COSTANTE EVOLUZIONE

TODAY PIAZZA IS A COMPANY READY TO FACE THE CHALLENGES OF A RAPIDLY AND CONSTANTLY EVOLVING MARKET

2 SEDI PRODUTTIVE
MANUFACTURING UNITS

13.500 M² DI SUPERFICIE TOTALE
OF TOTAL SURFACE

200 M² IL NOSTRO PUNTO VENDITA
OUR STORE & OUTLET

7 AGENTI IN ITALIA
AGENTS IN ITALY

360 DISTRIBUTORI IN ITALIA
DISTRIBUTORS IN ITALY

5 AGENTI NEL MONDO
AGENTS WORLDWIDE

150 DISTRIBUTORI NEL MONDO
DISTRIBUTORS WORLDWIDE

+50 I PAESI NEL MONDO IN CUI VENDIAMO
COUNTRIES WHERE WE OPERATE

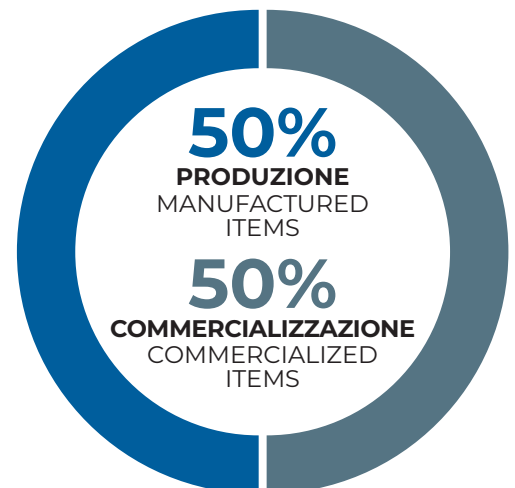

INVENTIAMO, PROGETTIAMO, PRODUCIAMO. SEMPRE QUI, DOVE SIAMO NATI!

WE INVENT, WE DESIGN, WE MANUFACTURE.
ALWAYS HERE, WHERE WE WERE BORN!

1

ASCOLTIAMO I PROFESSIONISTI, NE INTERPRETIAMO LE NECESSITÀ E CERCHIAMO DI CAPIRE LE LORO ESIGENZE

WE LISTEN TO PROFESSIONALS, INTERPRET THEIR REQUESTS AND TRY TO FULFILL THEIR NEEDS



2

TRADUCIAMO SUGGERIMENTI E CONSIGLI IN UN'IDEA DI PRODOTTO, IN GRADO DI SODDISFARE LE ASPETTATIVE DI CHI LO USERÀ

WE TURN TIPS AND ADVICES INTO A PRODUCT IDEA, THAT CAN MEET USERS' EXPECTATIONS



3

I DESIGNER CHE PROGETTANO PER PIAZZA DANNO FORMA ALLA NOSTRA IDEA TRADUCENDOLA IN UN PRODOTTO REALE

THE DESIGNERS WHO WORK FOR PIAZZA GIVE SHAPE TO OUR IDEA RESULTING IN A PROJECT



4

CON LA STAMPA 3D VIENE REALIZZATO UN PROTOTIPO IN MISURA REALE, SUL QUALE SI FANNO LE PRIME VERIFICHE RELATIVE A FORMA E FUNZIONALITÀ

WE CREATE A REAL SIZE PROTOTYPE, WITH 3D PRINTING, TO MAKE THE FIRST CHECKS ON SHAPE AND FUNCTIONALITY



5

IL NOSTRO UFFICIO RICERCA E SVILUPPO INGEGNERIZZA IL PRODOTTO E REALIZZA I DISEGNI DEFINITIVI PER LA CREAZIONE DEGLI STAMPI

R&D DEPARTMENT ENGINEERS THE PRODUCT AND CREATES THE FINAL DRAWINGS TO MAKE THE MOLDS

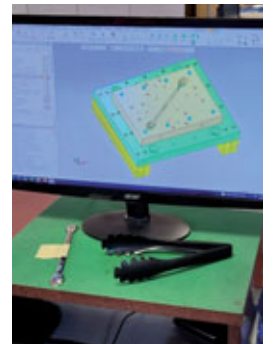

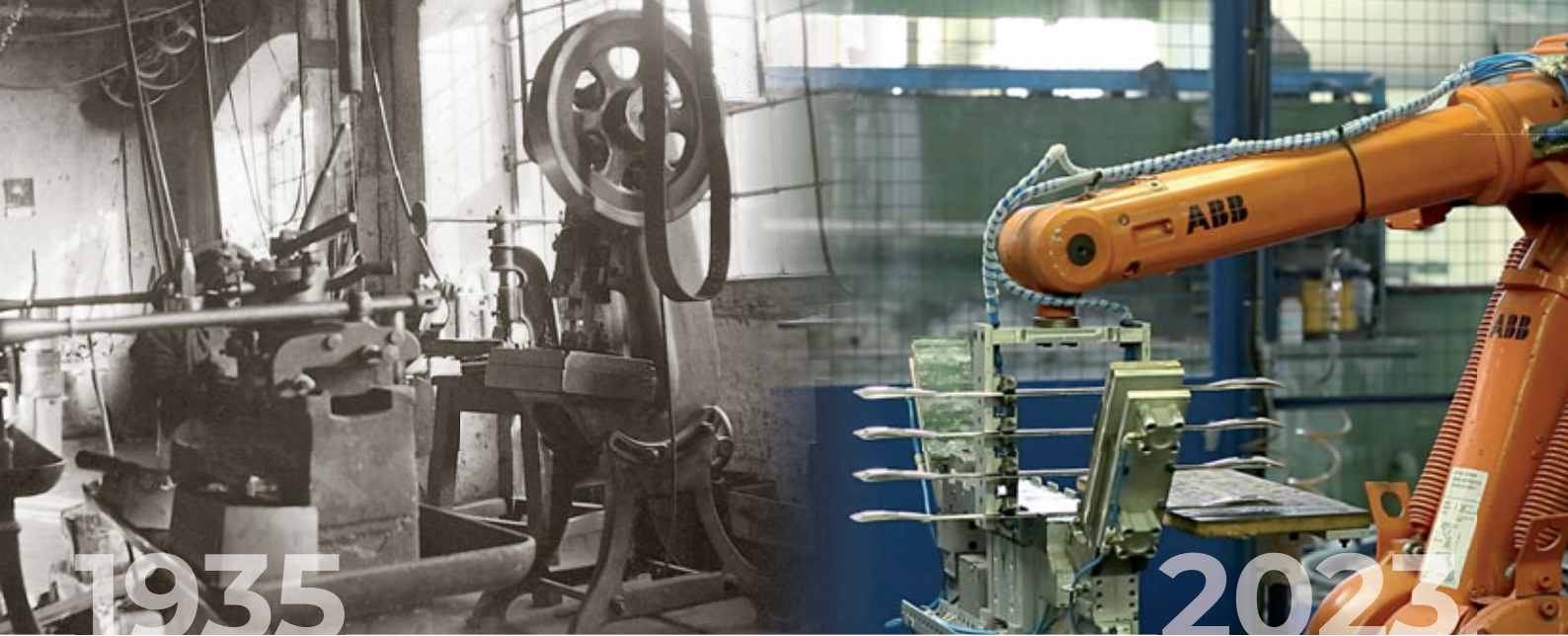

6

VENGONO FATTI GLI STAMPI CHE SERVIRANNO PER LA PRODUZIONE DEFINITIVA

WE MAKE THE MOLDS FOR THE FINAL PRODUCTION

7

PRIMA DI ESSERE MESSO IN COMMERCIO IL PRODOTTO VIENE ACCURATAMENTE TESTATO PER ESSERE CERTI DELLA SUA QUALITÀ

BEFORE BEING PUT ON THE MARKET, THE PRODUCT IS CAREFULLY TESTED TO BE SURE OF ITS QUALITY

8

IL PRODOTTO FINITO VIENE "VESTITO" CON IL PACKAGING E IMMESSO SUL MERCATO

THE FINISHED PRODUCT IS 'FINALIZED' WITH THE PACKAGING AND FINALLY LAUNCHED ON THE MARKET

9

SI RACCOLGONO I FEEDBACK, SIA POSITIVI CHE NEGATIVI, IN MERITO AL PRODOTTO E A TUTTE LE SUE CARATTERISTICHE

WE COLLECT THE FEEDBACK, BOTH POSITIVE AND NEGATIVE, REGARDING THE PRODUCT AND ALL ITS CHARACTERISTICS

10

CONTINUIAMO A LAVORARE SUL PRODOTTO PER MIGLIORARLO, PERFEZIONARLO E RENDERLO SEMPRE PIÙ VICINO AI BISOGNI DI CHI LO UTILIZZA

WE CONTINUE TO WORK ON THE PRODUCT TO IMPROVE IT, PERFECT IT AND MAKE IT CLOSER TO USERS' NEEDS

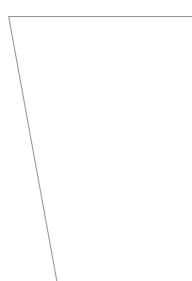
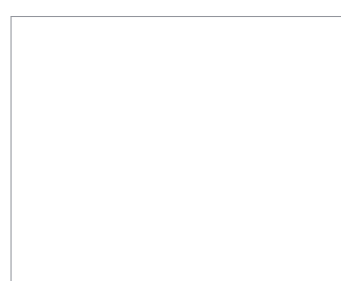
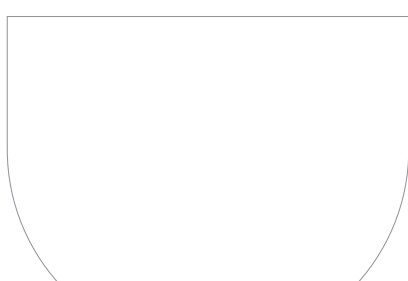
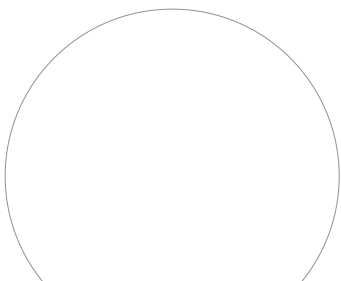
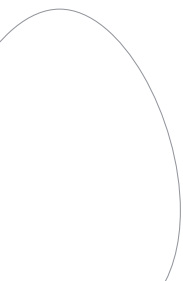

CON VOI OVUNQUE VOGLIATE, PER FARVI SENTIRE SEMPRE IN BUONE MANI.

WITH YOU WHEREVER YOU WANT,
TO MAKE YOU ALWAYS FEEL IN BUONE MANI*

Grazie alla nuova veste del nostro sito web www.piazza.it potete consultare, in qualunque momento e dovunque voi siate, l'intero nostro catalogo.

L'abbiamo pensato per rendere la vostra ricerca facile e veloce, secondo quell'idea di massima funzionalità che è il tratto caratteristico di tutti i nostri prodotti.

Inoltre, grazie ai nostri canali social, resterete sempre aggiornati in tempo reale su novità ed eventi.

Thanks to the new look of our website www.piazza.it you can browse our entire catalog everytime and everywhere.

Its design allows a quick and easy search. Being functional is the central idea for both our communication tools and products.

Moreover, thanks to our social channels, you will always have real-time updates on news and events.

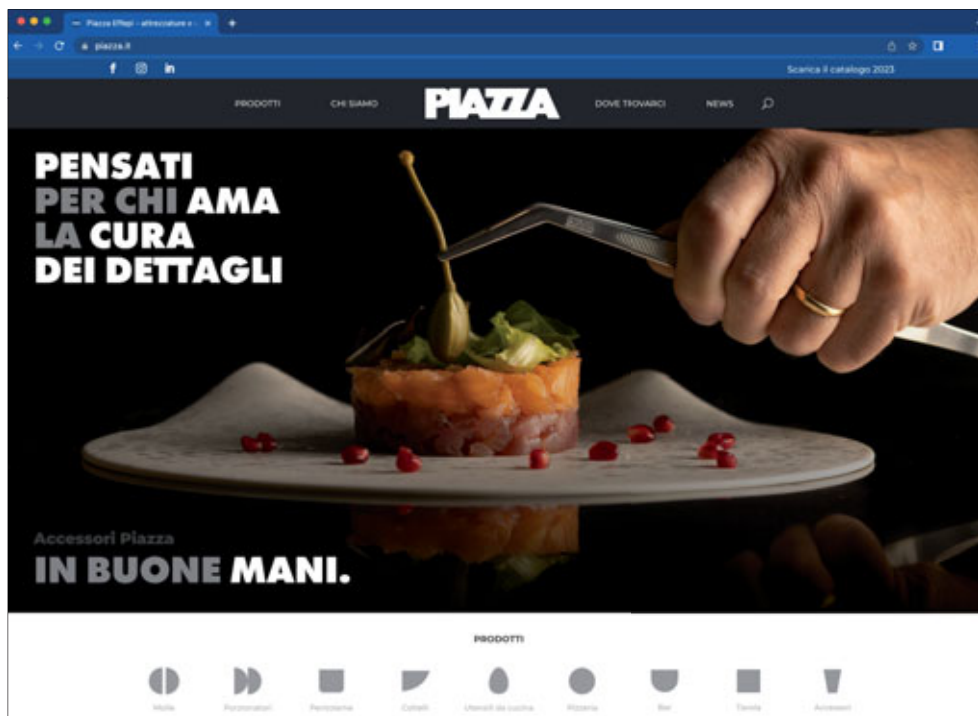

INQUADRA
IL QR CODE
E SCOPRI IL
NOSTRO SITO
SCAN THE
QR CODE
AND DISCOVER
OUR WEBSITE

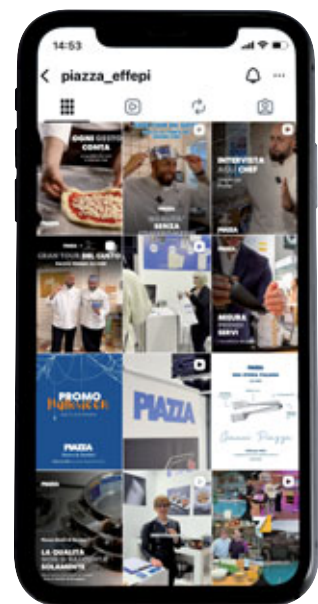

* The expression 'in buone mani' (translatable as 'in good hands') is a common Italian saying to reassure and make you feel sure about the quality, reliability, safety of a product or service

DESIDERATE UN PRODOTTO PERSONALIZZATO? LO POSSIAMO FARE!

DO YOU WISH A PERSONALIZED PRODUCT? WE CAN DO IT!

Siamo, da sempre, un'azienda di produzione attenta ai bisogni dei propri clienti.

È per questo che vogliamo offrire loro la possibilità di personalizzazione dei nostri prodotti con il logo o altri elementi. Anche il packaging, in base ai quantitativi, può essere personalizzato con la grafica fornita dal cliente.

Possiamo farlo in tempi rapidi e con la massima versatilità, grazie all'esperienza e alla passione delle persone che lavorano in PIAZZA.

Per saperne di più: piazza@piazza.it

We have always been a manufacturing company who cares about the needs of its customers.

That's why we want to offer them too the possibility of personalizing our products with their logo or other elements.

Even the packaging, based on the quantities, can be customized with graphics supplied by the customer.

We can do it quickly and with maximum versatility, thanks to experience and passion of the people who work in PIAZZA.

To know more: piazza@piazza.it



COLLABORARE CON I PROFESSIONISTI, IL NOSTRO "INGREDIENTE" PER MIGLIORARCI DI CONTINUO

COOPERATE WITH PROFESSIONALS,
OUR 'INGREDIENT' TO CONTINUOUSLY IMPROVE

Amiamo raccontare i nostri prodotti attraverso le mani sapienti dei migliori professionisti, accompagnandoli nei loro gesti quotidiani.

Il dialogo, l'ascolto e la collaborazione con loro fanno parte del nostro DNA aziendale. Ci offrono la loro esperienza per testare i nostri prodotti, valutandone praticità e resistenza, al fine di trovare le migliori soluzioni.

We love describing our products through the expert hands of the best professionals, supporting them in their daily gestures.

Communication, listening and cooperation with professionals are part of our corporate DNA. They offer us their experience to test our products, evaluating their practicality and resistance, in order to find the best solutions.



**I NOSTRI PARTNER
SUL TERRITORIO**
THE PARTNERS
IN OUR AREA



IDENTITÀ GOLOSE

Nasce nel gennaio del 2004 dall'idea di Paolo Marchi di dar vita al primo congresso italiano di cucina e pasticceria d'autore. PIAZZA ha creduto da subito a questo progetto e da allora ne è sponsor tecnico, fornendo le attrezzature alle cucine durante le varie fasi delle manifestazioni.

Born in January 2004 from a Paolo Marchi's idea: set up the first Italian congress of signature cuisine and pastry. Right from the beginning, PIAZZA trusted this project and since then it has been a technical sponsor, providing kitchen equipments and accessories during events and demonstrations.



AIBES

L'Associazione Italiana Barmen e Sostenitori riunisce ogni anno i professionisti e le aziende che operano nel mondo del bar, guidati dalla volontà di sostenere e tutelare la professione del barman. La storia di AIBES si intreccia con quella di PIAZZA poiché entrambi accomunati dall'impegno nel sostenere il mondo del bar in tutte le sue sfaccettature: mixology, flair e caffetteria.

A.I.B.E.S., Italian Barmen and Sponsor Association, gathers professionals and companies both working in bartending world and yearning to support and protect the profession of barman. A.I.B.E.S. and PIAZZA both share a commitment to support all sides of the world of bartending: mixology, flair and coffee bar.



AMBASCIATORI DEL GUSTO

L'Associazione Italiana Ambasciatori del Gusto nasce nel 2016 con l'idea di valorizzare e promuovere l'eccellenza dell'accoglienza e della ristorazione italiana. Si compone non solo di cuochi, ristoratori, pizzaioli, giornalisti, ricercatori e scrittori ma anche di una cerchia di partner che operano nel settore del Made in Italy. Tutti questi attori si uniscono per farsi ambasciatori, nel mondo, del concetto italiano di gusto e alta qualità.

The Italian Association Ambasciatori del Gusto was founded in 2016 with the aim of enhancing and promoting the excellence of Italian hospitality and dining. It comprises not only chefs, restaurateurs, pizza makers, journalists, researchers, and writers, but also a circle of partners operating in the Made in Italy sector. All these players come together to act as ambassadors, around the world, of the Italian concept of taste and high quality.





ACCESSORI

ACCESSORIES

MOLLE TONGS	12
PINZE SCISSOR SERVERS	18
PORZIONATORI GELATO ICE-CREAM SCOOPS	20
SPATOLE E BACINELLE GELATO ICE-CREAM SERVERS AND CONTAINERS	22
TAPPI VERSATORI POURERS	24
COLINI MESH STRAINERS	30



Molla per servire

Serving tongs	Cod.	L cm	Box
	010000	23	12



Molla per ghiaccio

Ice cube tongs	Cod.	L cm	Box
	010400	18	12



Molla per servire

Serving tongs	Cod.	L cm	Box
	010100	23	12



Molla per zucchero

Sugar tongs	Cod.	L cm	Box
	010500	12,5	12



Molla per pane a conchiglia

Bread tongs	Cod.	L cm	Box
	010200	26	12
	010223	23	12



Molla per dolci

Pastry tongs	Cod.	L cm	Box
	010600	18	12



Molla per spaghetti

Spaghetti tongs	Cod.	L cm	Box
	010300	23,5	12
	010326	26	12



GUARDA COME NASCONO
LOOK HOW THEY ARE BORN



MOLLE PIAZZA: SEMPLICEMENTE INDISPENSABILI
 PIAZZA TONGS: SIMPLY INDISPENSABLE

Le molle PIAZZA sono da sempre punto di riferimento per il mercato, sia per il design che per l'effettiva superiorità di un prodotto immancabile nella collezione di ogni professionista.

I dettagli risaltano l'unicità di ogni singola molla: la curvatura di alcune applicazioni, quale la molla spaghetti, come invito per raccogliere meglio gli alimenti, il molleggio che conferisce sempre la stessa maneggevolezza anche dopo un numero infinito di pressioni, grazie ad un accorgimento produttivo esclusivo e ancora oggi riservato, come le formule che resistono da anni a ogni tentativo di imitazione. Proprio questa sicurezza permette solo a PIAZZA di garantire l'inalterabilità delle proprie molle.

PIAZZA's tongs have always been the collection used as reference point for the market, both for design and for the effective superiority of a product that is a must for every professional's collection.

Lastly, the details highlight the uniqueness of each individual pair: the curvature of certain applications, such as the spaghetti tongs, which is like an invitation to gather up the food in the best way; or the spring which always gives the same manoeuvrability even after an infinite number of pressing, this thanks to an exclusive production device which is still secret today, as are the formulas which for years have resisted all attempts of imitation.

Precisely this certainty permits PIAZZA alone to guarantee the inalterability of its tongs.

LE "MOLLUNGHE"
 PIAZZA 'MOLLUNGHE'

Quattro pezzi speciali che grazie al loro esclusivo e caratteristico design, più lungo delle normali molle, daranno un'impronta raffinata al vostro buffet.

Four perfect items that, thanks to their unique and distinctive design, give an impression of great elegance for your buffet table.



Mollunga per spaghetti

Design by Michele Capuani

Buffet spaghetti tongs 'Mollunga'	Cod.	L cm	Box
	010700	30	12



Mollunga per servire

Design by Michele Capuani

Buffet tongs 'Mollunga'	Cod.	L cm	Box
	010800	30	12



Mollunga per carne e verdure

Design by Michele Capuani

Buffet meat tongs 'Mollunga'	Cod.	L cm	Box
	010900	30	12



Mollunga per toast e dolci

Design by Michele Capuani

Buffet toast tongs 'Mollunga'	Cod.	L cm	Box
	011000	30	12





Molla per ghiaccio

Ice cube tongs

Cod.	L cm	Box
011100	20	12



Molla per spaghetti

Spaghetti tongs

Cod.	L cm	Box
011800	19,5	12



Molla per zucchero

Sugar tongs

Cod.	L cm	Box
011200	11	12



Molla per dolci

Pastry tongs

Cod.	L cm	Box
011900	16,5	12



Molla per zucchero

Sugar tongs

Cod.	L cm	Box
011300	14	12



Molla per asparagi

Asparagus tongs

Cod.	L cm	Box
012000	19	12



Molla per asparagi individuale

Individual asparagus tongs

Cod.	L cm	Box
011400	13	12



Molla per insalata

Salad tongs

Cod.	L cm	Box
012100	19,5	12



Molla per ghiaccio

Ice cube tongs

Cod.	L cm	Box
011500	16	12



Molla per vegetali

Vegetables tongs

Cod.	L cm	Box
012200	19,5	12



Molla per lumache

Snail tongs

Cod.	L cm	Box
011600	16	12



Molla per servire

Serving tongs

Cod.	L cm	Box
012300	19,5	12





Molla per spaghetti

Spaghetti tongs	Cod.	L cm	Box
	012400	20,5	12



Pinza per servire

Serving tongs	Cod.	L cm	Box
	012800	24	12



Molla per toast e dolci

Toast tongs	Cod.	L cm	Box
	012500	21	12



Molla per affettati

Sliced ham tongs	Cod.	Box
	012900	12



Molla per asparagi

Asparagus tongs	Cod.	L cm	Box
	012600	20	12



NEW

Molla collezione "Allan Bay"

'Allan Bay' Collection tongs	Cod.	Box
	013000	6



Molla per carne e vegetali

Serving tongs	Cod.	L cm	Box
	012700	21	12



Molla per barbecue

Barbecue tongs	Cod.	L cm
	014000	50





Molla di precisione per cucina

Design by Michele Capuani

Precision kitchen tongs	Cod.	L cm	Box
	014500	30	12
	014515	15	12
	014523	23,5	12
	014540	40	12



Molla universale per cucina

Design by Michele Capuani

All-in-one kitchen tongs	Cod.	L cm	Box
	015000	30	12
	015012	12	12
	015018	18	12
	015023	23,5	12



Molla di precisione 40° per cucina

Design by Michele Capuani

40° precision kitchen tongs	Cod.	L cm	Box
	014600	30	12
	014615	15	12
	014623	23,5	12



Molla fonda per cucina

Design by Michele Capuani

Curved kitchen tongs	Cod.	L cm	Box
	015500	30	12
	015518	18	12
	015523	23,5	12



LE MOLLE TEST E KAIMAN: PENSATE DA LUCIANO TONA E CONCRETIZZATE DAL DESIGN DI MICHELE CAPUANI

THE TEST AND KAIMAN TONGS: AN ORIGINAL IDEA BY LUCIANO TONA, DESIGNED BY MICHELE CAPUANI



Molla Test

Design by Michele Capuani

Test tongs	Cod.	L cm	Box
	014100	13,5	12



Molla Kaiman

Design by Michele Capuani

Kaiman tongs	Cod.	L cm	Box
	014200	18	12



Un oggetto indispensabile per i professionisti della ristorazione grazie alla capacità di racchiudere in 13,5 cm molteplici funzioni.

- CUCCHIAINO PER L'ASSAGGIO DELLE PREPARAZIONI
- PINZA DALLA PRECISIONE CHIRURGICA
- MISURINO GRADUATO (0,5 CM)

A new tool measuring just 13.5 cm that's bound to become indispensable for all catering professionals as it offers so many different functions.

- SPOON FOR TASTING FOOD
- TONGS FOR ASSEMBLING PREPARATIONS WITH SURGICAL PRECISION
- SCALED MEASURE (0.5 CM)

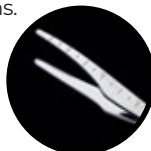

La Molla Kaiman affianca la Test, ampliando la vasta gamma delle molle cucina PIAZZA.

Progettata per la lavorazione del pesce.

- BECCUCCI DELISCATRICI DI PRECISIONE
- TACCHE POSTERIORI PER RIFINIRE LA SQUAMATURA
- SPECIALE ZIGRINATURA ANTISCIVOLO PER UNA PRESA SEMPRE SICURA

The Kaiman tongs is added to the popular Test tongs, extending the wide range of PIAZZA kitchen tongs. Specifically designed for fish.

- PRECISION FISH BONE REMOVERS
- REAR NOTCHES FOR PERFECT FISH SCALING
- NON-SLIP RIDGES FOR A SECURE GRIP





Molla universale nylon

Design by Michele Capuani

Nylon all-in-one tongs	Cod.	L cm	Box
	018600	23	12
	018700	30	12



Molla di precisione nylon & fiberglass

Design by Michele Capuani

Nylon & fiberglass precision tongs	Cod.	L cm	Box
	01833000	30	12



SBLOCCO FACILE
EASY RELEASE

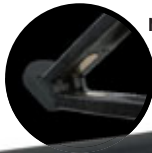

MOLLA A SCOMPARSA
DROP SPRING



Molla universale nylon & fiberglass

Design by Michele Capuani

Nylon & fiberglass all-in-one tongs	Cod.	L cm	Box
	01822302	23	12
	01823002	30	12
	01824002	40	



Molla toast nylon

Design by Michele Capuani

Nylon toast tongs	Cod.	L cm	Box
	01813000	30	12



THE SPECIAL MIX
NYLON & FIBERGLASS

Le nuove molle **PIAZZA** nate interamente in Italia.
Lo speciale polimero con cui vengono prodotte:
una combinazione di nylon e fibra di vetro, garantisce
praticità d'uso e durata nel tempo.

- RESISTENTI AL CALORE FINO A 220°C
- L'ASSENZA DI SALDATURE GARANTISCE MASSIMA IGIENE
- LAVABILI IN LAVASTOVIGLIE

PIAZZA new tongs are fully made in Italy.
They are made of a special polymer, a combination
of nylon and fiberglass, that gives great guarantee
of lasting in time and ease of use.

- HEAT RESISTANT UP TO 220°C (430°F)
- THE ABSENCE OF WELDINGS GUARANTEES MAXIMUM HYGIENE
- DISHWASHER SAFE





Pinza per dolci forgiata

Pastry scissor server	Cod.	L cm
	020000	18,5



Pinza per dolci forgiata

Pastry scissor server	Cod.	L cm
	020300	21
 Cod. 0203001	0203001	21



Pinza per dolci forgiata

Pastry scissor server	Cod.	L cm
	020100	20



Pinza per torta forgiata

Pie scissor server	Cod.	L cm
	020400	25



Pinza per dolci forgiata

Pastry scissor server	Cod.	L cm
	020200	20
 Cod. 0202001	0202001	20



Pinza per antipasti forgiata

Hors-d'ouvres scissor server	Cod.	L cm
	020500	19



NATE PER SFIDARE IL TEMPO
BORN TO BE TIMELESS

Le pinze sono uno degli articoli storici della produzione Piazza. Alcune di loro sono diventate dei "classici" tanto da essere presenti in catalogo sin dai primi anni '60 con lo stesso design di quelle odierne, a testimonianza di un'attenzione particolare nei confronti della funzionalità dei nostri prodotti, una caratteristica che ci contraddistingue da sempre. Ancora oggi, come allora, vengono interamente prodotte in Italia, ponendo la massima cura nella loro realizzazione e nel loro assemblaggio in modo da renderle pressoché indistruttibili. La disponibilità infine di pezzi particolari, quali le pinze "Mignon", rende la gamma Piazza una delle più complete sul mercato.



Pinza per antipasti forgiata

Hors-d'ouvres scissor server

Cod. **020600** L cm 19



Pinza per toast forgiata

Toast scissor server

Cod. **020900** L cm 19



Pinza per dolci "Mignon" forgiata

Midget scissor server 'Mignon'

Cod. **020700** L cm 15



Pinza per insalata forgiata

Salad scissor server

Cod. **021000** L cm 24



Pinza per dolci "Mignon" forgiata

Midget scissor server 'Mignon'

Cod. **020800** L cm 15



Pinza per forno

Hot plate holder

Cod. **021100** L cm 18,5



Scissor servers are one of Piazza's classic products. Indeed, some of these have appeared in our catalogue since the early 1960s, with the same design today. This proves just how valuable is the great attention we pay to the functionality of our products, a characteristic that has always distinguished us. Today, as in the past, these products are made entirely in Italy. We pay the utmost attention to their production and assembly to make them virtually indestructible. Finally, the availability of specific items, such as the "Mignon" scissor servers, means that the Piazza range is one of the most comprehensive on the market today.

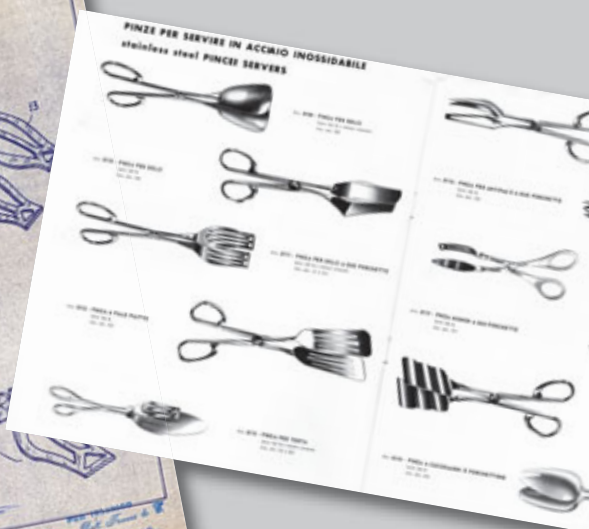
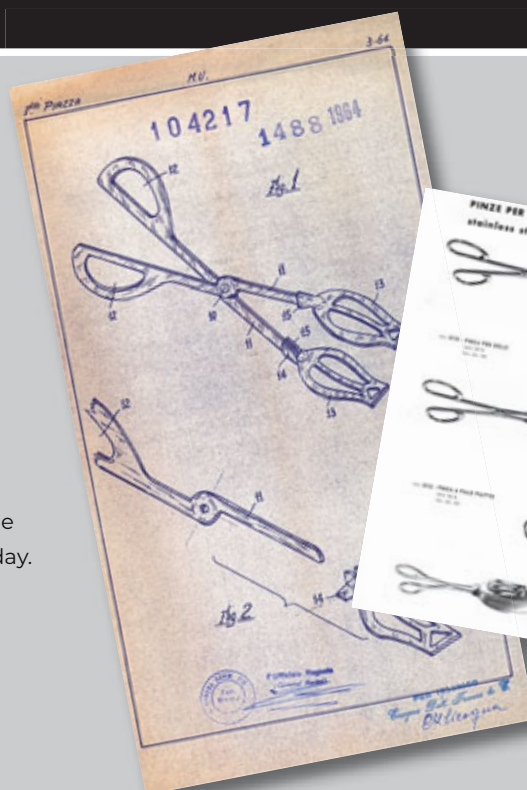

L'ABBIAMO INVENTATO NOI!
WE INVENTED IT!

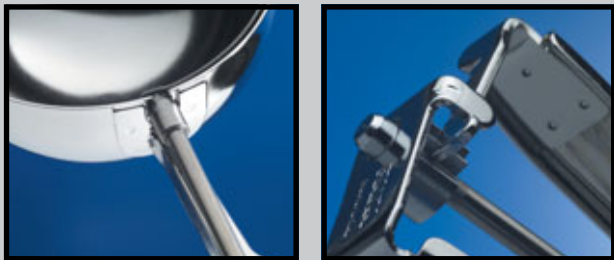

I porzionatori costituiscono, nell'assortimento PIAZZA, un'azienda nell'azienda. Il fattore determinante è l'idea, infatti, il brevetto originale di questo prodotto appartiene a PIAZZA e risale agli anni '60.

Da allora è "Il Porzionatore", che, rinnovato costantemente, rappresenta oggi il riferimento qualitativo del settore, con soluzioni tecniche impareggiabili, quali

- SALDATURE ED ACCOPPIAMENTI AL LIMITE DELL'IMPOSSIBILE
- UN DISEGNO ERGONOMICO PERFETTO
- UN MECCANISMO INDISTRUTTIBILE CHE SOPPORTA STRESS DA UTILIZZO PRESSOCHÉ INFINITI
- ASSORTIMENTO VASTISSIMO (13 DIVERSE CAPACITÀ)

In the PIAZZA assortment, ice cream scoops constitute a company within a company. The determining factor is the idea. In fact the original patent for this product belongs to PIAZZA and dates back to the 60's.

Since then the 'Porzionatore', constantly renewed, represents the sector qualitative reference today, with unparalleled technical solutions such as

- WELDS AND COUPLINGS TO THE LIMITS OF THE HIGH IMPOSSIBLE
- PERFECT ERGONOMIC DESIGN
- AN INDESTRUCTIBLE MECHANISM WHICH CAN TOLERATE ALMOST INFINITE USER STRESS
- WIDE ASSORTMENT (13 DIFFERENT CAPACITIES).

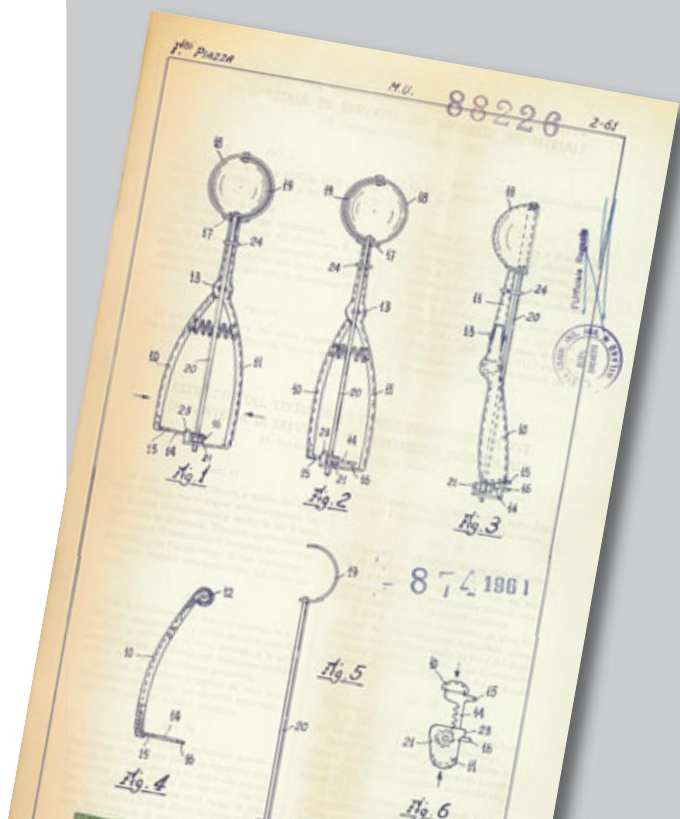

Porzionatore neoclassico

Ice-cream scoop	Cod.	Ø cm	Cap.	Box
	030008	7,6	1/8 Lt	4
	030010	7,3	1/10 Lt	4
	030012	6,8	1/12 Lt	4
	030016	6,1	1/16 Lt	4
	030020	5,8	1/20 Lt	6
	030024	5,3	1/24 Lt	6
	030030	5	1/30 Lt	6
	030036	4,7	1/36 Lt	6
	030040	4,5	1/40 Lt	6
	030050	4,1	1/50 Lt	6
	030060	3,8	1/60 Lt	6
	030070	3,5	1/70 Lt	6
	030099	3,1	1/100 Lt	6



CARATTERISTICHE TECNICHE

- Interamente in acciaio inox 18/10
- Composti da 12 particolari perfettamente assemblati con saldature a proiezione ad alta tecnologia
- Adatti al lavaggio in lavastoviglie
- Elettrolucidati con metodi alimentari nel rispetto delle norme ambientali
- Cremagliera con spessore di 2 mm per offrire una maggiore scorrevolezza
- Presenza di una bussolina di tenuta per impedire l'uscita dell'astina
- Scorrimento completo dell'astina sulla coppa per creare cerchi perfetti
- Testati per oltre un milione di palline

AVVERTENZE E CONSIGLI D'USO

- Per garantire un rendimento ottimale del porzionatore il gelato non dovrebbe avere una temperatura inferiore ai -15°C
- Si raccomanda di tenere il porzionatore sotto acqua corrente tiepida, ciò contribuisce a impedire la formazione di batteri e ne aumenta la scorrevolezza durante l'uso

TECHNICAL DATA

- Made from 100% 18/10 st. steel
- 12 perfectly assembled components with hi-tech projection welding
- Dishwasher suitable
- Electropolished with feed methods compliant with environmental regulations
- 2 mm-thick rack for better smoothness
- A bush to prevent the rod from coming out
- Full movement of the rod within the cup to create perfect circles
- Tested by producing more than a million balls of ice-cream

WARNING AND HINTS

- To guarantee top efficiency of the ice-cream scoop, the ice-cream shouldn't be colder than -15°C
- We recommend placing the scoop under warm running water before use to avoid the formation of bacteria and to allow it to slide better during use



Porzionatore ovale

Oval ice-cream scoop	Cod.	L cm	Cap.	Box
	030130	4,5 x 6	1/30 Lt	6



PORZIONATORE

ICE-CREAM SCOOP

LIGHT&STRONG



Porzionatore bianco con astina colorata

Ice-cream scoop, white with coloured steel bar

Design by Michele Capuani

Cod.	Ø cm	Cap.	Col.	Box
03522401	5,3	1/24 Lt	●	6
03522402	5,3	1/24 Lt	○	6
03522403	5,3	1/24 Lt	●	6
03522404	5,3	1/24 Lt	●	6
03522406	5,3	1/24 Lt	●	6
03522407	5,3	1/24 Lt	●	6
03523001	5	1/30 Lt	●	6
03523002	5	1/30 Lt	○	6
03523003	5	1/30 Lt	●	6
03523004	5	1/30 Lt	●	6
03523006	5	1/30 Lt	●	6
03523007	5	1/30 Lt	●	6
03523601	4,7	1/36 Lt	●	6
03523602	4,7	1/36 Lt	○	6
03523603	4,7	1/36 Lt	●	6
03523604	4,7	1/36 Lt	●	6
03523606	4,7	1/36 Lt	●	6
03523607	4,7	1/36 Lt	●	6
03524001	4,5	1/40 Lt	●	6
03524002	4,5	1/40 Lt	○	6
03524003	4,5	1/40 Lt	●	6
03524004	4,5	1/40 Lt	●	6
03524006	4,5	1/40 Lt	●	6
03524007	4,5	1/40 Lt	●	6



Il porzionatore Light&Strong nasce dalla ricerca e dallo sviluppo del nostro ufficio tecnico e trova forme e colori freschi e accattivanti grazie alla matita di Michele Capuani. Un piccolo, grande concentrato di tecnologia e design, 100% Made in Italy, capace di offrirvi prestazioni ineguagliabili, in gelateria come in cucina.

The ice-cream scoop Light&Strong is the result of the research and development of our engineering office, while Michele Capuani designed fresh and attractive shapes and colors. A small, yet a great extract of technology and design, fully Made in Italy, which gives you unequalled performance in both an ice-cream parlor and at home.

THE SPECIAL MIX

NYLON & FIBERGLASS

MATERIALE

L'INNOVATIVA COMPOSIZIONE DI NYLON E FIBERGLASS CONIUGA UN'ELEVATA RIGIDITÀ E UNA GRANDE RESISTENZA MECCANICA AD UNA STRAORDINARIA LEGGEREZZA. HA UN RANGE TERMICO DA -30°C A +170°C, È TRANQUILLAMENTE LAVABILE IN LAVASTOVIGLIE ED È PIENAMENTE A NORMA CON LE LEGGI CEE E FDA USA.

CREMAGLIERA

IL GIOCO DEL MECCANISMO, CALIBRATO ALLA PERFEZIONE, CONSENTE LA MASSIMA SCORREVOLEZZA CON IL MINIMO SFORZO DI PRESSIONE, RIDUCENDO QUINDI FATICA E STANCHEZZA.

FASCETTA

REALIZZATA IN ACCIAIO INOX OFFRE UN TAGLIO OTTIMALE DEL GELATO E, ASSIEME ALLA COPPA LUCIDATA, PRODUCE SEMPRE PALLINE PERFETTE.

ASTINA E MOLLA

ANCH'ESSE IN ACCIAIO INOX POSSIEDONO UN'EFFICACIA DI FUNZIONAMENTO SENZA PARI ASSOCIATA A MASSIMA ROBUSTEZZA, INALTERABILITÀ DI FUNZIONAMENTO E DURATA NEL TEMPO.

PERNO CENTRALE

IL CONTROLLO SCRUPOLOSO DELLE TOLLERANZE IN FASE DI STAMPAGGIO PRIMA ED IN ASSEMBLAGGIO POI, ASSIEME AL DESIGN COMPATTO, GARANTISCONO LA MASSIMA IGIENICITÀ DEL PORZIONATORE PER L'ASSENZA DI PUNTI OVE POSSA DEPOSITARSI LO SPORCO.

IMPUGNATURA

PERFETTAMENTE ERGONOMICA E, GRAZIE ALLA SPECIALE SUPERFICIE SATINATA, È TOTALMENTE ANTISCIVOLO PER UNA PRESA SEMPRE SALDA E SICURA.

MATERIAL

THE INNOVATIVE COMPOSITION OF NYLON AND FIBERGLASS MATCHES STIFFNESS, GREAT MECHANICAL STRENGTH AND EXTRAORDINARY LIGHTNESS. IT STANDS TEMPERATURES FROM -30°C TO +170°C, IS DISHWASHER SAFE AND FULLY COMPLIES WITH EEC AND FDA STANDARDS.

RACK

THE PERFECTLY ADJUSTED MECHANISM PROVIDES EXCELLENT SLIDING WITH MINIMUM PRESSURE EFFORT, THEN CUTTING DOWN FATIGUE AND TIREDNESS.

STRIP

MADE OF STAINLESS STEEL, IT PROVIDES THE BEST CUT OF ICE-CREAM AND, TOGETHER WITH THE POLISHED CUP, ALWAYS RESULTS IN PERFECT SHAPE SCOOPS.

ROD AND SPRING

THEY ARE ALSO MADE OF STAINLESS STEEL AND THEIR OPERATION IS UNPARALLELED; THEY ARE VERY STRONG, HAVE A LONG LIFE AND THEIR OPERATION UNDERGOES NO CHANGE.

CENTRAL HUB

CAREFUL CHECK ON ALLOWANCES, FIRST DURING THE MOLDING AND THEN THE ASSEMBLY STAGE, GUARANTEES, TOGETHER WITH COMPACT DESIGN, TOP HYGIENE OF THE SCOOP BECAUSE THERE ARE NO AREAS WHERE RESIDUES OF DIRT CAN SETTLE.

HANDLE

PERFECTLY ERGONOMIC AND, WITH ITS SPECIAL MATTE SURFACE, IT IS FULLY ANTI-SLIP FOR A STRONG AND SAFE GRIP AT ALL TIMES.





Spatola per gelato

Ice-cream server	Cod.	L cm	Box
	040020	20	5
	040025	25	5



Spatola per gelato manico tubolare chiuso

Ice-cream server	Cod.	L cm
	040125	25



Spatola per gelato manico colorato

Ice-cream server	Cod.	L cm	Col.
	040500	25	○
	040501	25	●
	040502	25	●
	040503	25	●



Spatola per gelato manico colorato trasparente 25 cm

Ice-cream server 25 cm	Cod.	L cm	Col.
	040507	25	○
	040511	25	●
	040512	25	●
	040513	25	●
	040517	25	●
	040518	25	●



Spatola per gelato manico colorato

Ice-cream server	Cod.	L cm	Col.	Box
	040600	30	○	5
	040601	30	●	5
	040602	30	●	5
	040603	30	●	5





Bacinella gelato 265 x 160

Ice-cream container	Cod.	L x W cm	H cm	cl
	045215	26,5 x 16	15	400
	045217	26,5 x 16	17	470



Bacinella gelato 330 x 165

Ice-cream container	Cod.	L x W cm	H cm
	045312	33 x 16,5	12
	045315	33 x 16,5	15
	045318	33 x 16,5	18



Bacinella gelato 360 x 165

Ice-cream container	Cod.	L x W cm	H cm	cl
	045408	36 x 16,5	8	350
	045412	36 x 16,5	12	500
	045415	36 x 16,5	15	650
	045418	36 x 16,5	18	770



Bacinella gelato 360 x 250

Ice-cream container	Cod.	L x W cm	H cm	cl
	045507	36 x 25	7	470
	045512	36 x 25	12	800



Coperchio in plexiglass

Plexiglass lid	Cod.	L x W cm
	045726	26,5 x 16
	045733	33 x 16,5



**Carapina stampata
200 x 250**

Cylindrical ice-cream container	Cod.	Ø cm	H cm
	045900	20	25





Tappo versatore con capsula di chiusura

Pouring cork with closure cap

Cod. **0500004**

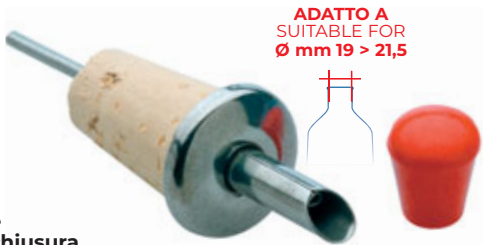

ADATTO A
SUITABLE FOR
Ø mm 19 > 21,5



Tappo versatore curvo

Curved pouring cork

Cod. **0503004**



ADATTO A
SUITABLE FOR
Ø mm 19 > 21



Tappo versatore dritto

Straight pouring cork

Cod. **0501004**



ADATTO A
SUITABLE FOR
Ø mm 19 > 21



Tappo versatore curvo con silicone

Curved pouring cork with silicone

Cod. **0503014**



ADATTO A
SUITABLE FOR
Ø mm 17,5 > 18



Tappo versatore dritto con silicone

Straight pouring cork with silicone

Cod. **0501014**



ADATTO A
SUITABLE FOR
Ø mm 17,5 > 18



Tappo versatore ricuperatore

Drop stop pouring cork

Cod. **0505004**

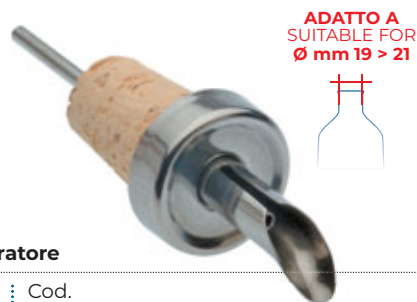

ADATTO A
SUITABLE FOR
Ø mm 19 > 21



Tappo versatore dritto con capsula di chiusura

Straight pouring cork with closure cap

Cod. **0502004**

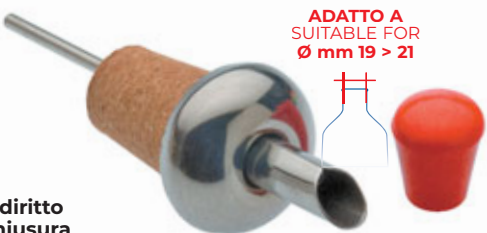

ADATTO A
SUITABLE FOR
Ø mm 19 > 21



Tappo versatore ricuperatore con silicone

Drop stop pouring cork with silicone

Cod. **0505014**



ADATTO A
SUITABLE FOR
Ø mm 17,5 > 18



Confezione 4 tappi versatori (2 pz. 050000 + 2 pz. 050300)

Pack 4 pouring corks (2 pcs. 050000 + 2 pcs. 050300) Cod. **050601**





I TAPPI VERSATORI PIAZZA: SINTESI PERFETTA DI TRADIZIONE E INNOVAZIONE

PIAZZA POURERS: A PERFECT SYNTHESIS BETWEEN TRADITION AND INNOVATION

I tappi versatori sono parte della storia di PIAZZA.

L'applicazione di materiali e tecnologie innovative all'oggetto che per primo ha dato avvio alla produzione di utensili professionali in acciaio PIAZZA, è simbolo di costante ed approfondita ricerca di qualità e funzionalità.

Sintesi di acciaio e silicone il tappo versatore in Soflex esalta le caratteristiche positive di entrambi i materiali; all'ormai sperimentata praticità dei particolari in acciaio:

- BECCUCCIO SALVAGOCCIA
- CANNUCCIA PER L'ARIA
- ROBUSTO ED IGIENICO COPERCHIO

si aggiunge un rivestimento lamellare in soflex, che, per le intrinseche caratteristiche del materiale e per l'appositamente studiata conformazione a lamelle, garantisce un impiego perfetto,

- INSERIMENTO FACILE E RESISTENZA ALLA FUORIUSCITA
- CHIUSURA ERMETICA
- SCORRIMENTO AGEVOLATO DI OGNI TIPO DI LIQUIDO (OLIO, LIQUORE, VINO)
- NESSUN RISCHIO DI PERDITA, DI SCIVOLAMENTO DEL TAPPO, DI PERMANENZA DI ODORE SULLA PARTE IN SOFLEX

Pourers are part of PIAZZA's industrial history.

The application of innovative materials and technologies to the object which first triggered production of PIAZZA professional utensils in steel, is symbol of the constant, in-depth search for quality and functionality.

A synthesis of steel and silicone, the pourers in silicone highlight the positive features of both materials: to the well tried practicality of the details in steel,

- DRIP-CATCHER SPOUT
- AIR INLET AND TOUGH
- HYGIENIC LID

is added a lamellar covering in silicone which, due to the intrinsic characteristics of the material and the specially designed lamella conformation, guarantees perfect use

- EASY INSERTION
- RESISTANCE TO LEAKS,
- HERMETIC CLOSURE WITH EASY FLOW OF ALL TYPES OF LIQUIDS (OIL, LIQUEUR, VINEGAR)
- NO RISK OF LEAKING, OF THE CORK SLIPPING OR OF ODOURS REMAINING ON THE PART IN SILICONE





ADATTO A
SUITABLE FOR
Ø mm 17,5 > 18

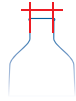

Design by Marco Valente

Tappo versatore con silicone Design-Pourer

Design-Pourer silicone gear
Cod. **050800**



ADATTO A
SUITABLE FOR
Ø mm 17,5 > 18

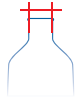

Design by Marco Valente

Tappo versatore con silicone Tech-Pourer

Tech-Pourer silicone gear
Cod. **0509004**



ADATTO A
SUITABLE FOR
Ø mm 17,5 > 18

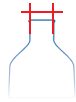

Design by Marco Valente

Tappo versatore con silicone Tech-Pourer

Tech-Pourer silicone gear
Cod. **0510004**



ADATTO A
SUITABLE FOR
Ø mm 17,5 > 18

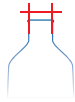

Design by Marco Valente

Tappo versatore con silicone Tech-Pourer

Tech-Pourer silicone gear
Cod. **0511004**

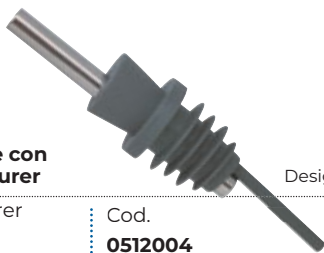

ADATTO A
SUITABLE FOR
Ø mm 17,5 > 18

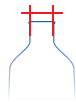

Design by Marco Valente

Tappo versatore con silicone Soft-Pourer

Pourer Soft-Pourer
Cod. **0512004**

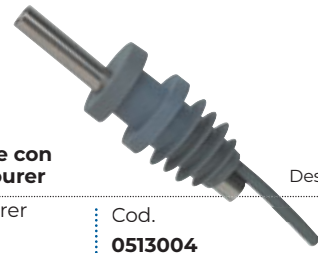

ADATTO A
SUITABLE FOR
Ø mm 17,5 > 18



Design by Marco Valente

Tappo versatore con silicone Soft-Pourer

Pourer Soft-Pourer
Cod. **0513004**



051400
051500

051600

051601

Capsula, sughero e silicone per tappo versatore

Capsule cork and silicone for pouring cork	Cod.	Per/For	Box
	051400	050000	24
	051500	050200	24
	051600		24
	051601		24



Silicone per tappi Pourers

Spare part for Pourers	Cod.	Box
	051700	24



ADATTO A
SUITABLE FOR
Ø mm 17,5 > 18



Design by Marco Valente

Tappo versatore per vino con chiusura

Closable wine-pouring stopper
Cod. **051800** Box 18



Silicone per tappo vino (051800)

Spare part for pourer 051800	Cod.	Box
	051900	24





ADATTO A
SUITABLE FOR
Ø mm 17,5 > 18



Tappo versatore dosatore in acciaio inox

Measuring stainless steel pourer
Cod. **05321012**

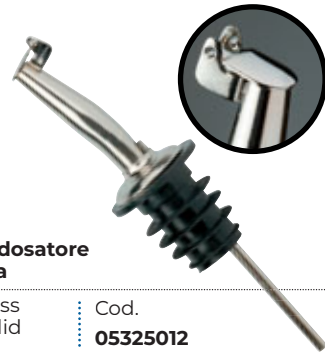

ADATTO A
SUITABLE FOR
Ø mm 17,5 > 18



Tappo versatore dosatore inox con chiusura

Measuring stainless steel pourer with lid
Cod. **05325012**



NEW

ADATTO A
SUITABLE FOR
Ø mm 17,5 > 18



Tappo versatore dosatore inox con cappuccio

Measuring stainless steel pourer with closure cap
Cod. **0532552**



Tappo versatore continuo

Design by Marco Valente

Continuous pourer	Cod.	Col.	Box
	05350112		4
	05350312		4
	05350412		4
	05350612		4



BPour, tester per dosaggi

BPour, pour check
Cod. **053290** Ø cm 10,5 H cm 16,5



Tappo versatore metrico

Metric pourer	Cod.	ml	Col.
	0540153	15	
	0540203	20	
	0540253	25	
	0540303	30	
	0540353	35	
	0540403	40	
	0540503	50	



CONFEZIONE
2
PEZZI/PIECES

Cod. 0533002

CONFEZIONE
6
PEZZI/PIECES



Cod. 0533006



ADATTO A
SUITABLE FOR
Ø mm 18,5 > 21



Tappo versatore SteadySpout 2.0

SteadySpout 2.0 pourer Cod. 0533002
  Cod. 0533006

STEADYSPOUT 2.0

THE EVOLUTION OF THE METAL POURER

Con SteadySpout avrai un versaggio sempre costante a 157BPM, l'unità di misura usata dai bartender per calibrare perfettamente la quantità di liquido nella preparazione dei cocktail.

INALTERABILE

La speciale plastica dotata di "memoria" torna alla forma originale con un passaggio in lavastoviglie.

ROBUSTO

Composto da 2 soli pezzi invece che 4.

Più solido e più resistente all'usura.

Maggiore durata nel tempo rispetto ai diretti concorrenti.

PRECISO

Velocità d'uscita del liquido garantita dalla presa d'aria. Nessuna goccia sia all'inizio che alla fine del versaggio. Ideale per la tecnica del jumping.

UNIVERSALE

Disegno e materiale delle lamelle offrono massima presa e inserimento/disinserimento facile e veloce.

Il doppio modulo di diametro lo rende adatto a bottiglie con collo da Ø18 a Ø21,5 mm.

BREVETTATO

Concepito, studiato e interamente progettato dall'ufficio tecnico di PIAZZA. 100% Made in Italy.

CARATTERISTICHE TECNICHE

- Cannuccia in acciaio inox 18/10 AISI 304 con lavorazione al laser
- Diametro, rastrematura e inclinazione della cannuccia perfettamente calibrati sia all'interno che all'esterno
- Lavabile in lavastoviglie

TECHNICAL SPECIFICATIONS

- Reed in AISI 304 18/10 laser processed stainless steel
- Perfectly calibrated diameter, tapering and inclination of the reed, both inside and outside
- Dishwasher friendly

With SteadySpout, the rate of pouring is always constant at 157BPM, the unit of measurement used by bartenders to perfectly calibrate the quantity of liquid in the preparation of cocktails.

NEVER CHANGES

Special plastic with "memory" returns to the original shape simply by putting it through the dishwasher.

STURDY

Composed of only 2 pieces rather than 4.

Sturdier and more resistant to wear and tear.

Longer duration compared to the other competitors.

ACCURATE

Pouring speed of the liquid guaranteed by the air intake. No spills either at the start or end of the pouring.

Perfect for the jumping technique.

UNIVERSAL

Design and material of the reed valves offer maximum grip and an easy and fast plugging/unplugging.

The double diameter module makes it suitable for bottles with necks of diameters from Ø18 to Ø21.5 mm.

PATENTED

Conceived, developed and entirely designed by PIAZZA's technical office. Entirely manufactured in Italy



FEEL THE BEAT
MIX THE DRINKS



SCOPRI COME
LO PRODUCIAMO
DISCOVER HOW
WE MANUFACTURE IT

**Colino a rete**

Mesh strainer

Cod.	Ø cm
060007	7
060009	9
060012	12
060014	14
060016	16
060018	18

**Colino a rete conico**

Conical mesh strainer

Cod.	Ø cm
060107	7
060109	9
060112	12
060114	14
060116	16
060118	18



Un vasto assortimento di articoli finalizzati a “scolare” gli alimenti, denota un’attenzione particolare al problema. La serie dei colini si distingue per la rete impiegata, la cui trama è fitta e resistente, nonché per la sua saldatura al corpo, rifinita e durevole.

A vast assortment of articles for straining foodstuffs, featuring special attention paid to the problem. The series of strainers is distinguished by the tough, close-mesh employed as well as by the lasting and well-finished welding to the body.



CUCINA

COOKWARE

MOLLE CUCINA KITCHEN TONGS	32
COLLEZIONI PENTOLAME COOKWARE COLLECTIONS	34
ACCESSORI CUCINA KITCHEN ACCESSORIES	47
ARTICOLI TECNICI TECHNICAL ITEMS	66
COLTELLI KNIVES	68
CESTELLI RACKS	76
GASTRONORM IN ACCIAIO INOX GASTRONORM IN STAINLESS STEEL	78
GASTRONORM IN PLASTICA GASTRONORM IN PLASTIC	82
GASTRONORM IN POLIPROPILENE GASTRONORM IN POLYPROPYLENE	83



Molla Test Design by Michele Capuani

Test tongs	Cod.	L cm	Box
	014100	13,5	12



Molla Kaiman Design by Michele Capuani

Kaiman tongs	Cod.	L cm	Box
	014200	18	12



Molla di precisione per cucina Design by Michele Capuani

Precision kitchen tongs	Cod.	L cm	Box
	014500	30	12
	014515	15	12
	014523	23,5	12
	014540	40	12



Molla di precisione 40° per cucina Design by Michele Capuani

40° precision kitchen tongs	Cod.	L cm	Box
	014600	30	12
	014615	15	12
	014623	23,5	12



Molla universale per cucina Design by Michele Capuani

All-in-one kitchen tongs	Cod.	L cm	Box
	015000	30	12
	015012	12	12
	015018	18	12
	015023	23,5	12



Molla fonda per cucina Design by Michele Capuani

Curved kitchen tongs	Cod.	L cm	Box
	015500	30	12
	015518	18	12
	015523	23,5	12



SBLOCCO FACILE
EASY RELEASE

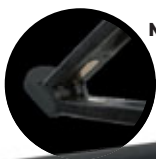

MOLLA A SCOMPARSA
DROP SPRING

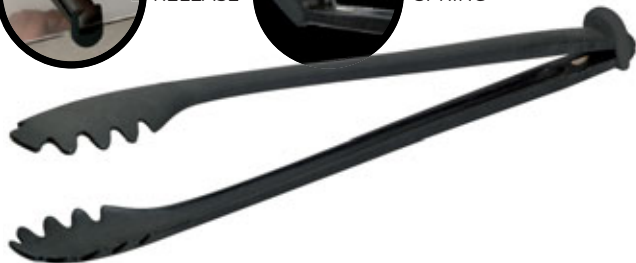

Molla universale nylon & fiberglass Design by Michele Capuani

Nylon & fiberglass all-in-one tongs	Cod.	L cm	Box
	01822302	23	12
	01823002	30	12
	01824002	40	12



Molla di precisione nylon & fiberglass Design by Michele Capuani

Nylon & fiberglass precision tongs	Cod.	L cm	Box
	01833000	30	12



Molla universale nylon Design by Michele Capuani

Nylon all-in-one tongs	Cod.	L cm	Box
	018600	23	12
	018700	30	12



SCOPRI LA QUALITÀ
100% MADE IN ITALY
DISCOVER THE QUALITY
100% MADE IN ITALY

Per la cucina professionale "massima funzionalità" è una parola d'ordine.

Tutte le linee di pentolame PIAZZA sono frutto di una ricerca avanzata e costante e interpretano in modo esemplare questa importante esigenza.

La nuova collezione PROChef ne è l'esempio migliore, unendo perfettamente tradizione e innovazione.

Conserva un particolare classico, come la maniglia brevettata, con intatte tutte le caratteristiche che ne garantiscono una resistenza infinita e le migliori performance del mercato.

Il suo nuovo fondo termoconduttore, progettato per resistere ai lavaggi intensivi, è realizzato con un'anima in alluminio di maggiore spessore, racchiusa in un fondello di acciaio inox. I due materiali vengono fusi insieme grazie ad un'avanzata tecnologia di battitura.

L'alluminio più spesso, posizionato più vicino ai bordi della pentola, assicura una distribuzione uniforme e rapida del calore, riducendo i tempi di cottura e il dispendio di energia, migliorando così la resa dei piatti.

Il rivestimento in acciaio inox protegge il fondo dall'usura e dagli agenti esterni, preservando le prestazioni nel tempo e ottimizzando la diffusione del calore su tutti i sistemi di cottura.

- ALTI SPESSORI
- ROBUSTEZZA
- RESISTENZA ALL'USURA
- FINITURE DI PREGIO
- SALDATURE INDISTRUTTIBILI
- MANIGLIE CAVE ED ERGONOMICHE

- THICK
- TOUGH
- WEAR-RESISTANT
- FINE FINISH
- INDESTRUCTIBLE WELDING
- HOLLOW ERGONOMIC HANDLES



'Top functionality' is the keyword for professional cooking. All PIAZZA lines of pots and pans are the result of continuous state-of-the-art research and a perfect example of interpretation of this important requirement.

The new PROChef collection, which perfectly mixes tradition and innovation, is the best example of this concept.

Maintains the patented handle, a classical detail, with its all characteristics that have guaranteed and still guarantees endless strength and top performance on the market.



Its new heat-conducting base, designed to withstand intensive washing, is made of a thicker aluminum core, enclosed in a stainless steel base. The two materials are fused together thanks to advanced bonding technology. The thicker aluminum, positioned closer to the edges of the pot, ensures uniform and rapid heat distribution, reducing cooking times and energy waste, thus improving dishes' quality.

The stainless steel coating protects the base from wear and external agents, preserving performance over time and optimizing heat diffusion on all cooking hobs.

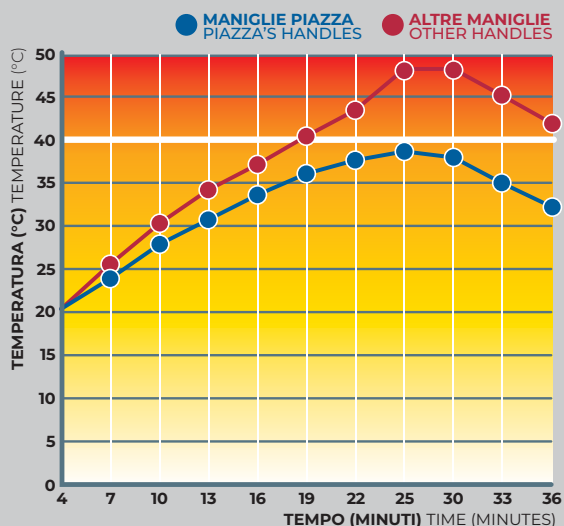

IL GRAFICO MOSTRA I VALORI DELLE TEMPERATURE RAGGIUNTI DALLE MANIGLIE DELLE PENTOLE DELLA SERIE "PROCHEF" PIAZZA CONFRONTATI CON QUELLI DELLE ALTRE MANIGLIE PRESENTI SUL MERCATO. COME SI PUÒ NOTARE, SE VENGONO USATE IN MANIERA CORRETTA, LE MANIGLIE PIAZZA NON RAGGIUNGONO MAI IL PUNTO CRITICO DEI 40°C (SOPRA IL QUALE LE MANI SI SCOTTANO) ANCHE QUANDO L'ACQUA È A 98°C.

THE GRAPHIC SHOWS THE VALUES OF THE TEMPERATURE REACHED BY PIAZZA'S HANDLES COMPARED TO THE ONE OF THE OTHER HANDLES ON THE MARKET. AS YOU SEE THE TEMPERATURE OF PIAZZA'S HANDLES NEVER REACHES THE CRITIC POINT OF 40°C EVEN WITH WATER AT 98°C, IF USED IN THE PROPER WAY. ABOVE THIS CRITIC POINT HANDS GET BURNT.



NEW



Casseruola bassa

Shallow cookpot

Cod.	Ø cm	H cm	Lt
096024	24	8	3,6
096028	28	9	5,6
096032	32	10	8,1
096036	36	11	11,3
096040	40	13	16,4
096045	45	14	22,4
096050	50	16	31,6



NEW



Casseruola media

Medium cookpot

Cod.	Ø cm	H cm	Lt
096216	16	8	1,6
096220	20	9	2,8
096224	24	10	4,5
096228	28	12	7,4
096232	32	15	12,1
096236	36	17	17,4
096240	40	19	24
096245	45	22	35,1
096250	50	25	49,3



NEW



Casseruola alta

Deep cookpot

Cod.	Ø cm	H cm	Lt
096416	16	11	2,2
096420	20	13	4,1
096424	24	15	6,8
096428	28	18	11,1
096432	32	20	16,1
096436	36	22	22,5
096440	40	25	31,5
096445	45	28	44,7
096450	50	32	63



NEW



Casseruola bassa 1 manico

Shallow saucepan

Cod.	Ø cm	H cm	Lt
096124	24	8	3,6
096128	28	9	5,6



NEW



Casseruola media 1 manico

Medium saucepan

Cod.	Ø cm	H cm	Lt
096316	16	8	1,6
096320	20	9	2,8
096324	24	10	4,5
096328	28	12	7,4



NEW



Casseruola alta 1 manico

Deep saucepan

Cod.	Ø cm	H cm	Lt
096512 ←	12 *	8	0,9
096514 ←	14 *	9	1,4
096516	16	11	2,2
096520	20	13	4,1
096524	24	15	6,8
096528	28	18	11,1



* CON MANICO DIFFERENTE
WITH A DIFFERENT HANDLE

NEW



Pentola

Pan	Cod.	Ø cm	H cm	Lt
	096620	20	20	6,3
	096624	24	24	10,9
	096628	28	28	17,3
	096632	32	32	25,8
	096636	36	36	36,7
	096640	40	40	50,3
	096645	45	45	71,7
	096650	50	50	98,3

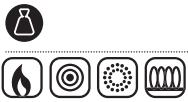

NEW

Casseruola bombata

Curved saute pan	Cod.	Ø cm	H cm	Lt
	091216	16	6	1
	091218	18	6	1,2
	091220	20	6,5	1,5
	091222	22	7	1,95
	091224	24	7,5	2,5



NEW

Padella in acciaio con rivestimento antiaderente

Steel frying pan with non-stick coating	Cod.	Ø cm	H cm
	091720	20	4,5
	091724	24	5
	091728	28	5,5
	091732	32	6
	091736	36 *	6,5
	091740	40 *	7



* CON CONTROMANICO WITH A SECOND HANDLE



NEW

Wok con rivestimento antiaderente

Wok with non-stick coating	Cod.	Ø cm	H cm
	091928	28	9



NEW

Padella

Frying pan	Cod.	Ø cm	H cm
	096720	20	4,5
	096724	24	5
	096728	28	5,5
	096732	32	6
	096736	36	6,5
	096740	40 *	7
	096745	45 *	7,5
	096750	50 *	8

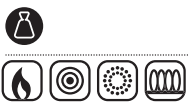

* CON CONTROMANICO WITH A SECOND HANDLE



NEW

Tegame

2-handled frying pan	Cod.	Ø cm	H cm
	096820	20	4,5
	096824	24	5
	096828	28	5,5
	096832	32	6
	096836	36	6,5
	096840	40	7
	096845	45	7,5
	096850	50	8



Coperchio

Lid	Cod.	Ø cm
	092916	16
	092920	20
	092924	24
	092928	28
	092932	32
	092936	36
	092940	40
	092945	45
	092950	50





Casseruola bassa

Shallow cookpot	Cod.	Ø cm	H cm	Lt
	093028	28	9	5,5
	093032	32	10	8
	093036	36	11	11,2
	093040	40	13	16,3
	093045	45	14	22,3
	093050	50	16	31,4



Padella

Frying pan	Cod.	Ø cm	H cm	Lt
	093720	20	4	1,2
	093724	24	4	1,7
	093728	28	5	2,9
	093732	32	5	3,8
	093736	36	6,5	6,3
	093740	40	7	8,4



Casseruola media

Medium cookpot	Cod.	Ø cm	H cm	Lt
	093220	20	10,5	3,3
	093224	24	11	5
	093228	28	13	8
	093232	32	16	12,9



Casseruola media 1 manico

Medium saucepan	Cod.	Ø cm	H cm	Lt
	093316	16	9,5	1,9
	093320	20	10,5	3,3
	093324	24	11	5
	093328	28	12	7,5



Casseruola alta

Deep cookpot	Cod.	Ø cm	H cm	Lt
	093416	16	12	2,4
	093420	20	14	4,4
	093424	24	16	7,2
	093428	28	18	11,1
	093432	32	20	16,1
	093436	36	22	22,4
	093440	40	25	31,4
	093445	45	28	44,5
	093450	50	32	62,8



Casseruola alta 1 manico

Deep saucepan	Cod.	Ø cm	H cm	Lt
	093516	16	12	2,4
	093520	20	14	4,4
	093524	24	16	7,2
	093528	28	18	11,1



Coperchio

Lid	Cod.	Ø cm
	093916	16
	093920	20
	093924	24
	093928	28
	093932	32
	093936	36
	093940	40
	093945	45
	093950	50



Pentola

Pan	Cod.	Ø cm	H cm	Lt
	093624	24	24	10,9
	093628	28	28	16
	093632	32	32	25,8
	093636	36	36	36,6
	093640	40	40	50,2
	093645	45	45	71,5





NEW

Tegame

2-handled frying pan	Cod.	Ø cm	H cm
	096820	20	4,5
	096824	24	5
	096828	28	5,5
	096832	32	6
	096836	36	6,5
	096840	40	7
	096845	45	7,5
	096850	50	8

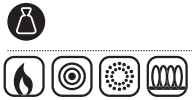

NEW

Casseruola bombata

Curved saute pan	Cod.	Ø cm	H cm	Lt
	091216	16	6	1
	091218	18	6	1,2
	091220	20	6,5	1,5
	091222	22	7	1,95
	091224	24	7,5	2,5



NEW

Padella in acciaio con rivestimento antiaderente

Steel frying pan with non-stick coating	Cod.	Ø cm	H cm
	091720	20	4,5
	091724	24	5
	091728	28	5,5
	091732	32	6
	091736	36 *	6,5
	091740	40 *	7



* CON CONTROMANICO
WITH A SECOND HANDLE



NEW

Wok con rivestimento antiaderente

Wok with non-stick coating	Cod.	Ø cm	H cm
	091928	28	9



LE PADELLE ANTIADERENTI: PRATICHE, ROBUSTE, INALTERABILI
NON-STICK FRYING PANS: PRACTICAL, ROBUST, INALTERABLE



Le padelle antiaderenti **PIAZZA** vantano il trattamento di alta qualità **Teflon® Platinum Plus**.

La speciale tecnologia multistrato assicura prestazioni superiori in fase di cottura, impedisce ai cibi di attaccarsi al fondo e resiste in modo ottimale a graffi ed abrasioni, consentendo così l'utilizzo di accessori da cucina in metallo. Sono facili da pulire e possono essere tranquillamente lavate in lavastoviglie.

Our **PIAZZA** non-stick frying pans are all subject to the high quality **Teflon® Platinum Plus** treatment. The special multi-layer technology guarantees superior performance during cooking, preventing food from sticking to the base and providing optimal resistance against scratches and abrasion, whilst also allowing metal kitchen utensils to be used. Our frying pans are easy to clean and are all fully dishwasher-safe.

TEMPERATURA OTTIMALE DI COTTURA OPTIMAL COOKING TEMPERATURE	240° C (464° F)
TEMPERATURA MASSIMA DI UTILIZZO MAXIMUM USE TEMPERATURE	340° C (644° F)

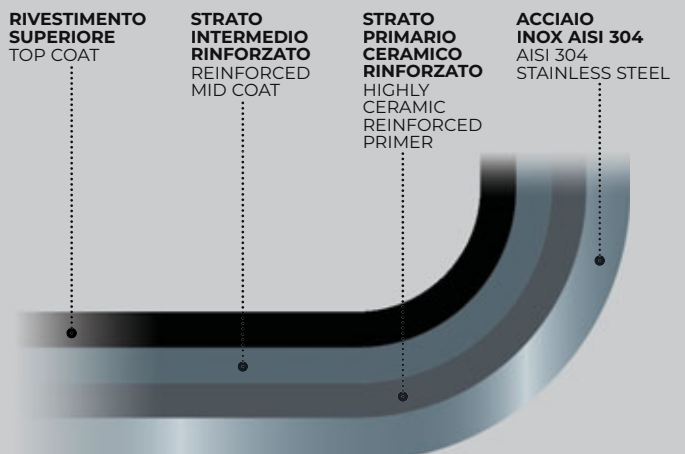

Teflon® è un marchio commerciale registrato di E.I. Du Pont de Nemours and Company
Teflon® is a registered trademark of E.I. Du Pont de Nemours and Company



Rostiera rettangolare alta

High rectangular roaster	Cod.	L x W cm	Lt
	101525	25 x 18	3
	101530	30 x 22	4
	101535	35 x 25	6
	101540	40 x 28	9
	101545	45 x 30	13
	101550	50 x 35	17,5
	101560	60 x 40	27



Vassoio rettangolare

Rectangular tray	Cod.	L x W cm
	101630	30 x 23
	101635	35 x 28
	101640	40 x 30
	101645	45 x 35
	101650	50 x 35
	101655	55 x 35
	101660	60 x 40



Casseruola bassa

Shallow cookpot	Cod.	Ø cm	H cm	Lt
	102024	24	8	3,6
	102028	28	9,3	5,6
	102032	32	10,6	8,1
	102036	36	12	11,3
	102040	40	13,3	16,4
	102045	45	15	22,4
	102050	50	16,6	31,6



Casseruola media

Medium cookpot	Cod.	Ø cm	H cm	Lt
	102220	20	10	3
	102224	24	12	5,5
	102228	28	14	8,5
	102232	32	16	13
	102236	36	18	18
	102240	40	20	25
	102245	45	22,5	36
	102250	50	25	49



Casseruola media 1 manico

Medium saucepan	Cod.	Ø cm	H cm	Lt
	102316	16	8	1,5
	102320	20	10	3
	102324	24	12	5,5
	102328	28	14	8,5



Casseruola alta

Deep cookpot	Cod.	Ø cm	H cm	Lt
	102420	20	13,3	4
	102424	24	16	7
	102428	28	18,6	11,5
	102432	32	21,3	17
	102436	36	24	24,5
	102440	40	26,6	34





Casseruola alta 1 manico

Deep saucepan	Cod.	Ø cm	H cm	Lt
	102516	16	10,6	2
	102520	20	13,3	4
	102524	24	16	7



Pentola

Pan	Cod.	Ø cm	H cm	Lt
	102620	20	20	6
	102624	24	24	11
	102628	28	28	17
	102632	32	32	26
	102636	36	36	37
	102640	40	40	50
	102645	45	45	71,5
	102650	50	50	98

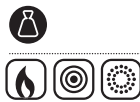

Padella svasata bassa

Shallow flared frying pan	Cod.	Ø cm	H cm
	102720	20	4,5
	102724	24	5
	102728	28	5,5
	102732	32	6
	102736	36	6,5
	102740	40	7



Padella svasata alta

Deep frying pan	Cod.	Ø cm	H cm
	1027200	20	5
	1027240	24	6
	1027280	28	6,5
	1027320	32	7
	1027360	36	7,5
	1027400	40	8,5



Tegame

2-handed frying pan	Cod.	Ø cm	H cm
	102820	20	4,5
	102824	24	6
	102828	28	6,5
	102832	32	7
	102836	36	7,5
	102840	40	8
	102845	45	8
	102850	50	8



Coperchio

Lid	Cod.	Ø cm
	102916	16
	102920	20
	102924	24
	102928	28
	102932	32
	102936	36
	102940	40
	102945	45
	102950	50





Casseruola bassa antiaderente

Shallow cookpot with non-stick coating

Cod.	Ø cm	H cm	Lt
105024	24	8	3,5
105028	28	9,5	6
105032	32	10,5	8,5



Casseruola media antiaderente

Medium cookpot with non-stick coating

Cod.	Ø cm	H cm	Lt
105220	20	10	3
105224	24	12	5,5
105228	28	14	8,5



Casseruola media 1 manico antiaderente

Medium saucepan with non-stick coating

Cod.	Ø cm	H cm	Lt
105316	16	8	1,5
105320	20	10	3
105324	24	12	5,5



Padella svasata bassa antiaderente

Shallow flared frying pan with non-stick coating

Cod.	Ø cm	H cm
105724	24	5
105728	28	5,5
105732	32	6
105736	36	6,5
105740	40	7



Padella svasata alta antiaderente

Deep frying pan with non-stick coating

Cod.	Ø cm	H cm
1057200	20	5
1057240	24	6
1057280	28	6,5
1057320	32	7
1057360	36	7,5
1057400	40	8,5



Tegame svasato antiaderente

Flared pan with non-stick coating

Cod.	Ø cm	H cm
105824	24	6
105828	28	6,5
105832	32	7
105836	36	7,5
105840	40	8



Le collezioni di pentolame multistrato 3-PLY e 4-PLY sfruttano le diverse peculiarità dei singoli materiali che le compongono.

Nascono così assortimenti completi, studiati per offrirvi prestazioni di assoluta eccellenza, senza rinunciare a praticità e maneggevolezza in ogni situazione di preparazione e servizio, in cucina come in sala.

- SPESSORE 1,2 MM (3-PLY) E 2 MM (4-PLY)
- BORDO A VERSARE
- UTILIZZABILI SU OGNI TIPO DI PIASTRA DI COTTURA (GAS, INDUZIONE, ELETTRICA, VETROCERAMICA) GARANTENDO SEMPRE CONDUCIBILITÀ OTTIMALE
- LA PERFETTA ERGONOMIA DEL MANICO IN ACCIAIO INOX CONSENTE UNA PRESA SEMPRE SICURA E CONFORTEVOLE
- IL PROFILO DELLA SALDATURA DI MANICO E MANIGLIE OFFRE GARANZIA DI MASSIMA TENUTA MENTRE L'APERTURA SUPERIORE NE PERMETTE IL RAFFREDDAMENTO GRAZIE AL PASSAGGIO DELL'ARIA. IL DISEGNO APERTO FORNISCE INOLTRE LA MASSIMA IGIENICITÀ IN FASE DI LAVAGGIO
- NELLA COLLEZIONE 4-PLY IL FONDO IN ACCIAIO NON È APPLICATO, MA MESSO A NUDO RIMUOVENDO LO STRATO ESTERNO IN RAME, PER OFFRIRE ROBUSTEZZA E DURATA NEL TEMPO
- NEI DIAMETRI DA 8 A 16 CM IL COPERCHIO PUÒ ESSERE COMODAMENTE AGGANCIATO AL BORDO DELLE CASSERUOLE GRAZIE AL PARTICOLARE DISEGNO DEL TRAVERSINO

The multi-layer cookware collections 3-PLY and 4-PLY takes advantage of the different peculiarities of the materials they are made of.

The results are complete ranges, designed to bring you excellent performance.

Always practical and easy to use in kitchen and in service room.

- THICK 1.2 MM (3-PLY) AND 2 MM (4-PLY)
- POURING EDGE
- SUITABLE FOR GAS, INDUCTION, HOTPLATES AND CERAMIC, ALWAYS MAINTAINING HIGH CONDUCTIVITY
- ERGONOMIC HANDLES IN STAINLESS STEEL DESIGNED TO GIVE A SAFE AND COMFORTABLE GRIP
- THE SHAPE OF WELDING OF THE HANDLES ENSURES THE BEST SEALING WHILE THE UPPER OPENING ALLOWS COOLING. THE OPEN OUTLINE GUARANTEES THE EXCELLENT HYGIENE
- THE STEEL BOTTOM IS NOT APPLIED, YET EXPOSED BY REMOVING THE EXTERNAL COPPER LAYER: THIS RESULTS IN GREATER STRENGTH AND LONG-LIFE
- THE LIDS WITH DIAMETERS FROM 8 TO 16 CM CAN BE EASILY HOOKED TO THE RIM OF THE CASSEROLES THANKS TO THE SPECIAL DESIGN OF THE KNOB





Casseruola bassa

Shallow cookpot

Cod.	Ø cm	H cm	Lt
110028	28	9	5,6
110032	32	10	8



Casseruola media

Medium cookpot

Cod.	Ø cm	H cm	Lt
110210 ←	10	4,5	0,35
110212 ←	12	6	0,7
110214 ←	14	7	1
110216 ←	16	8	1,6
110220	20	9	2,8
110224	24	10	4,5
110228	28	12	7,4



Casseruola alta

Deep cookpot

Cod.	Ø cm	H cm	Lt
110408 ←	8	5	0,25
110410 ←	10	6,5	0,5
110412 ←	12	8	0,9
110414 ←	14	9	1,4
110416 ←	16	11	2,2
110420	20	13	4,1
110424	24	15	6,8
110428	28	18	11
110432	32	20	16
110436	36	22	22,5

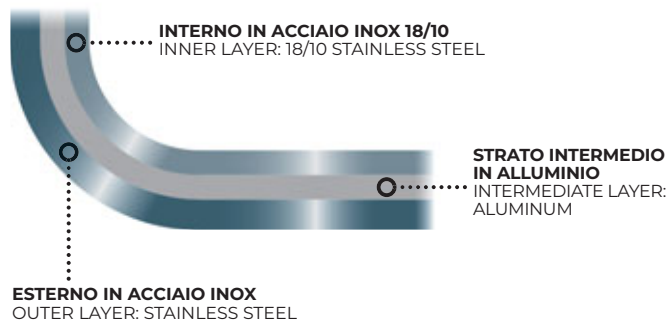

Casseruola media 1 manico

Medium saucepan

Cod.	Ø cm	H cm	Lt
110310	10	4,5	0,35
110312	12	6	0,7
110314	14	7	1
110316	16	8	1,6



Casseruola alta 1 manico

Deep saucepan

Cod.	Ø cm	H cm	Lt
110508	8	5	0,25
110510	10	6,5	0,5
110512	12	8	0,9
110514	14	9	1,4





Padella

Frying pan	Cod.	Ø cm	H cm
	110710 ←	10	3
	110712 ←	12	3
	110714 ←	14	3
	110716 ←	16	3
	110720	20	4,5
	110724	24	5
	110728	28	5,5
	110732	32	6
	110736	36	6



Tegame

Two-handled frying pan	Cod.	Ø cm	H cm
	110810	10	3
	110812	12	3
	110814	14	3
	110816	16	3

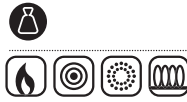

Casseruola bombata

Curved saute pan	Cod.	Ø cm	H cm	Lt
	111218	18	6,5	1,2
	111220	20	7	1,5
	111222	22	7,5	1,9
	111224	24	8	2,5

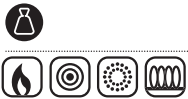

Padella antiaderente

Frying pan non-stick	Cod.	Ø cm	H cm
	111720	20	4,5
	111724	24	5
	111728	28	5,5
	111732	32	6
	111736	36	6
	111740	40 *	6,5



* CON CONTROMANICO
WITH A SECOND HANDLE



Coperchio

Lid	Cod.	Ø cm
	112908 ←	8
	112910 ←	10
	112912 ←	12
	112914 ←	14
	112916 ←	16
	092920	20
	092924	24
	092928	28
	092932	32
	092936	36
	092940	40





Casseruola media

Medium cookpot

Cod.	Ø cm	H cm	Lt
113210	10	4,5	0,25
113212	12	6	0,5
113214	14	7	0,9
113216	16	8	1,4



Casseruola alta

Deep cookpot

Cod.	Ø cm	H cm	Lt
113408	8	5	0,2
113410	10	6,5	0,4
113412	12	8	0,75
113414	14	9	1,2
113416	16	11	2



Padella

Frying pan

Cod.	Ø cm	H cm
113710	10	3,5
113712	12	3,5
113714	14	3,5
113716	16	3,5



Tegame

Two-handed frying pan

Cod.	Ø cm	H cm
113810	10	3
113812	12	3
113814	14	3
113816	16	3



Coperchio

Lid

Cod.	Ø cm
112908	8
112910	10
112912	12
112914	14
112916	16

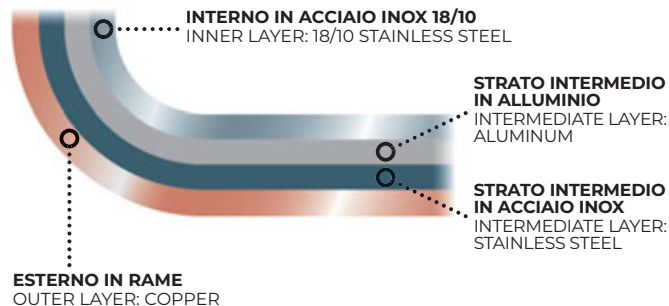







Spicchio per casseruola alta

Strainer for deep
casserole

Cod.	Por.	Ø cm
120128	1/3	28
120132	1/3	32
120136	1/4	36
120140	1/4	40



Spicchio a rete per casseruola alta

Mesh strainer
for deep casserole

Cod.	Por.	Ø cm
120228	1/3	28
120232	1/3	32
120236	1/4	36
120240	1/4	40



Scaldapasta

Warmer

Cod.	Ø cm
120318	18
120320	20
120324	24
120328	28



Chinois con gancio di appoggio anteriore

Chinois

Cod.	Ø cm
120516	16
120518	18
120520	20
120524	24



Chinois a rete

Chinois

Cod.	Ø cm
120620	20
120624	24



Chinois a rete con protezione in filo

Chinois wire protection

Cod.	Ø cm
120720	20
120724	24





Tazzone con manico tubolare

Kitchen bowl	Cod.	Ø cm	cl
	120916	16	125
	120918	18	150
	120920	20	200
	120922	22	300
	120924	24	500



Tazzone tondo con manico tubolare

Round kitchen bowl	Cod.	Ø cm	cl
	121016	16	125
	121018	18	150
	121020	20	200



Bagnomaria

Bain marie pot	Cod.	Ø cm	H cm	cl
	121212	12	14	150
	121214	14	16	250
	121216	16	18	350
	121218	18	20	500
	121220	20	22	700



Timballo per dolci

Pie mould	Cod.	Ø cm	H cm	cl
	121506	5	5	6
	121511	6	6	11
	121515	6,5	6,5	15
	121517	7	7	17
	121528	8	8	28



Misurino graduato

Measuring jug	Cod.	cl
	121605	50
	121610	100
	121620	200



DIMENSIONI REALI
REAL DIMENSIONS

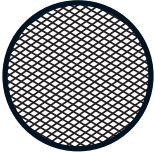

FORI HOLES
1 x 0,7 mm



Setaccio inox a velo

Stainless steel
fine sieve

Cod.	Ø cm
121721	21
121730	30
121735	35



DIMENSIONI REALI
REAL DIMENSIONS

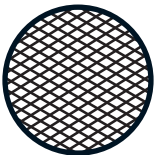

FORI HOLES
2 x 1,15 mm



Setaccio inox farina

Stainless steel
flour sieve

Cod.	Ø cm
121821	21
121830	30
121835	35



DIMENSIONI REALI
REAL DIMENSIONS

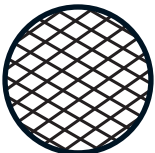

FORI HOLES
3,35 x 2,15 mm



Setaccio inox pane

Stainless steel bread
crumbs sieve

Cod.	Ø cm
121930	30
121935	35



DIMENSIONI REALI
REAL DIMENSIONS

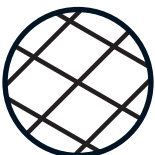

FORI HOLES
9,8 x 7,5 mm



Setaccio inox pesce

Stainless steel
fish sieve

Cod.	Ø cm
122030	30
122035	35



Bacinella

Bowl

Cod.	Ø cm	H cm	cl
130116	16,5	6,5	75
130120	20,5	8	150
130125	25	10,5	300
130127	27	11	400
130129	29,5	12,5	500
130133	33,5	13,5	800
130139	39,5	16	1400



**Bacinella per pasticceria
e cucina bordata**

Bowl

Cod.	Ø cm	H cm	cl
130616	16	9	100
130618	18	9	150
130621	21	10	200
130625	25	12,5	375
130628	28,5	13	500
130633	33	14,5	800
130637	37	16	1000
130641	41	18	1500



Colapasta conico in alluminio

Aluminium conical
pasta strainer

Cod.	Ø cm
135635	35
135640	40
135645	45
135650	50





Placca alluminio microforata

Micro-perforated aluminium plate	Cod.	L x W cm	H cm
	251030	30 x 40	1
	251032	32 x 53	1
	251060	40 x 60	1



Teglia cottura ferro blu diamantata con X di rinforzo

Blue iron baking tray with reinforcement X	Cod.	L x W cm	H cm
	252063	40 x 60	2



Teglia cottura ferro blu con pareti dritte

Blue iron baking tray with straight edges	Cod.	L x W cm	H cm
	252061	40 x 60	2



Teglia cottura alluminio forata

Perforated aluminium baking tray	Cod.	L x W cm	H cm
	252161	40 x 60	2



Teglia cottura alluminata con pareti dritte

Aluminized baking tray with straight edges	Cod.	L x W cm	H cm
	252061	40 x 60	2



Teglia cottura tonda ferro blu

Round blue iron baking tray	Cod.	Ø cm	H cm
	252514	14	2,5
	252516	16	2,5
	252518	18	2,5
	252520	20	2,5
	252522	22	2,5
	252524	24	2,5
	252526	26	2,5
	252528	28	2,5
	252530	30	2,5
	252532	32	2,5
	252536	36	2,5
	252540	40	2,5
	252545	45	2,5
	252550	50	2,5



Teglia cottura alluminata antiaderente con pareti dritte

Aluminized baking tray with non stick coating and straight edges	Cod.	L x W cm	H cm
	252062	40 x 60	2





Teglia cottura alluminio

Round baking tray	Cod.	Ø cm	H cm
	252521	20	2,5
	252525	24	2,5
	252529	28	2,5
	252533	32	2,5



Teglia cottura alluminio

Aluminium baking tray	Cod.	L x W cm	H cm
	253135	35 x 35	3
	253140	30 x 40	3
	253150	35 x 50	3
	253160	40 x 60	3



Teglia cottura ferro blu

Blue iron baking tray	Cod.	L x W cm	H cm
	253030	23 x 30	3
	253035	28 x 35	3
	253040	30 x 40	3
	253045	35 x 45	3
	253050	35 x 50	3
	253060	40 x 60	3
	253065	45 x 65	3



Tortiera alta ferro blu

Blue iron high-sided cake pan	Cod.	Ø cm	H cm
	254014	14	4
	254016	16	4
	254018	18	4
	254020	20	4
	254022	22	4
	254024	24	4
	254026	26	4
	254028	28	4
	254030	30	4
	254032	32	4
	254036	36	4
	254040	40	4
	254045	45	4
	254050	50	4
	254060	60	4



Teglia cottura ferro blu con pareti svasate

Blue iron baking tray with flared corners	Cod.	L x W cm	H cm
	253041	30 x 40	3
	253061	40 x 60	3



**Mestolo unipezzo inox 18/10**Ladle one piece
inox 18/10

Cod.	Ø cm	L cm	cl
150006	6 *	31	6
150007	7	34,5	8
150008	8	36	12,5
150009	9	36	19
150010	10	43	25
150012	12	52	50
150014	14	55	75
150016	16	61	100
150018	18	64	150
150020	20	72	200



* CON BECCO WITH BEAK

**Schiumarola unipezzo inox 18/10**Skimmer one piece
inox 18/10

Cod.	Ø cm	L cm
150108	8	33,5
150110	10	43,5
150112	12	47,5
150114	14	50,5
150116	16	55,5
150118	18	58,5
150120	20	65,5

**Forchettone a due punte unipezzo inox 18/10**Meat fork one piece
inox 18/10

Cod.	L cm
150242	42
150253	53

**Paletta con fori unipezzo inox 18/10**Perforated lifter one
piece inox 18/10

Cod.	L x W cm	L cm
150300	11 x 14	47,5

**Paletta senza fori unipezzo inox 18/10**Lifter one piece
inox 18/10

Cod.	L x W cm	L cm
150400	11 x 14	47,5

**Schiumarola a rete saldata inox 18/10**Mesh welded skimmer
inox 18/10

Cod.	Ø cm	L cm
152300	15	54

**Cucchiaione fondo unipezzo inox 18/10**Deep spoon one piece
inox 18/10

Cod.	L x W cm	L cm
150800	11 x 7	40,5

**Cucchiaione fondo manico di costa unipezzo inox 18/10**Deep side spoon
one piece inox 18/10

Cod.	L x W cm	L cm
150900	11 x 7	37

**Cucchiaione unipezzo inox 18/10**Large spoon one piece
inox 18/10

Cod.	L x W cm	L cm
151100	9,5 x 7	33,5

**Cucchiaione con fori unipezzo inox 18/10**Perforated large spoon
one piece inox 18/10

Cod.	L x W cm	L cm
151200	9,5 x 7	33,5





**Mestolo unipiece**

Ladle one piece

Cod.	Ø cm	L cm	cl
153006	6	37	6
153008	8	39	12,5
153010	10	45	25
153012	12	50	50
153014	14	54	75
153016	16	60	100

**Paletta con fori unipiece**

Perforated lifter one piece

Cod.	L x W cm	L cm
153400	10 x 9	48

**Schiumarola unipiece**

Skimmer one piece

Cod.	Ø cm	L cm
153108	8	36
153110	10	42
153112	12	48
153114	14	53
153116	16	57

**Paletta unipiece**

Lifter one piece

Cod.	L x W cm	L cm
153401	10 x 9	48

**Forchettone unipiece**

Meat fork one piece

Cod.	L cm
153242	50

**Cucchiaione fondo unipiece**

Deep spoon one piece

Cod.	L x W cm	L cm	cl
153800	10 x 7	47	

**Cucchiaione fondo manico di costa unipiece**

Deep side spoon one piece

Cod.	L x W cm	L cm	cl
153900	7 x 10	44	





Spatola professionale in nylon rinforzato con fiberglass

Professional spatula in nylon reinforced with fiberglass	Cod.	L cm	Box
	285021	30	6
	285022	35	6
	285023	40	6

FINO A UP TO +260°C

Spatola professionale "Vasetto" in plastica

Professional plastic spatula for jar	Cod.	L cm
	285000	25

FINO A UP TO +160°C



Spatola professionale in plastica

Professional plastic spatula	Cod.	L cm
	285001	25
	285002	35
	285003	45

FINO A UP TO +160°C



Spatola professionale applicazione in silicone

Professional spatula with silicone blade	Cod.	L cm
	285012	35

FINO A UP TO +300°C



SPATOLE IN PLASTICA: IDEALI IN OGNI PREPARAZIONE
 PLASTIC SPATULAS: IDEAL IN ALL KINDS OF PREPARATION

Le spatole professionali in plastica di PIAZZA vantano caratteristiche che le rendono ideali per tutte le situazioni di preparazione. Robuste e leggere al tempo stesso, l'ottima flessibilità dell'applicazione consente loro di adattarsi perfettamente ad ogni tipo di angolo.

- MANICO IN MATERIALE COMPOSITO (POLIAMMIDE E FIBERGLASS) RESISTENTE FINO A +220°C
- APPLICAZIONI RESISTENTI ALLE ALTE TEMPERATURE - SILICONE FINO A +300°C - COPOLIESTERE TERMOPLASTICO FINO A +160°C
- IDEALI PER L'USO SU FONDI ANTIADERENTI
- STERILIZZABILI E LAVABILI IN LAVASTOVIGLIE
- PROGETTATE E SVILUPPATE DA PIAZZA
- TOTALMENTE PRODOTTE IN ITALIA



PIAZZA'S professional, plastic spatulas have special features that make them ideal for all kinds of food preparation. Sturdy and light at the same time and the great flexibility of the blade enables them to adapt perfectly to every type of angle.

- HANDLE IN COMPOSITE MATERIAL (POLYAMIDE AND GLASS FIBRE), RESISTANT UP TO +220°C / 428°F
- BLADES RESISTANT TO HIGH TEMPERATURES - SILICONE UP TO +300°C / 572°F - THERMOPLASTIC COPOLYESTER UP TO +160°C / 320°F
- PERFECT FOR USE ON NON-STICK SURFACES
- CAN BE STERILISED AND ARE DISHWASHER FRIENDLY
- DESIGNED AND DEVELOPED BY PIAZZA
- ENTIRELY MANUFACTURED IN ITALY



**Cucchiaione nylon & fiberglass**

Design by Michele Capuani

Nylon & fiberglass
large spoon

Cod.

156000

L cm

38

156100

30

**Forchettone 2 punte nylon & fiberglass**

Design by Michele Capuani

Nylon & fiberglass
meat fork 2 prongs

Cod.

15723400

L cm

34

**Mestolo nylon & fiberglass
con becco a versare**

Design by Michele Capuani

Nylon & fiberglass
ladle with beak

Cod.

15700600

Ø cm

6

L cm

31

cl

4

**Mestolo nylon & fiberglass**

Design by Michele Capuani

Nylon & fiberglass ladle

Cod.

15700800

Ø cm

8

L cm

33

cl

10

15701000

10

35

20

**Mestolo pizza nylon & fiberglass**

Design by Michele Capuani

Nylon & fiberglass
pizza ladle

Cod.

15790900

Ø cm

9

L cm

35

cl

17

**Schiumarola nylon & fiberglass**

Design by Michele Capuani

Nylon & fiberglass
skimmer

Cod.

15711000

Ø cm

10

L cm

33

15711200

12

35

**Cucchiaione liscio nylon & fiberglass**

Design by Michele Capuani

Nylon & fiberglass
large spoon

Cod.

15780000

L cm

35

**Cucchiaione forato nylon & fiberglass**

Design by Michele Capuani

Nylon & fiberglass
perforated large spoon

Cod.

15780100

L cm

35



THE SPECIAL MIX NYLON & FIBERGLASS

La nuova linea di mestolame PIAZZA nasce interamente in Italia. Lo speciale polimero con cui viene prodotta: una combinazione di nylon e fibra di vetro, ne garantisce praticità d'uso e durata nel tempo.

- LA PARTICOLARE FORMA DEI MANICI UNISCE MASSIMA ROBUSTEZZA E GRANDE LEGGEREZZA
- DIMENSIONE DEI FORI DIFFERENZIATA A SECONDA DELL'UTILIZZO
- PERFETTAMENTE RESISTENTE AL CALORE FINO A 220°C
- LAVABILE IN LAVASTOVIGLIE: IGIENICITÀ GARANTITA

PIAZZA new ladle line is fully made in Italy. It is made of a special polymer, a combination of nylon and fiberglass, that gives great guarantee of lasting in time and ease of use.

- THE UNIQUE SHAPE OF THE HANDLES COMBINE MAXIMUM STRENGTH AND GREAT LIGHTNESS
- HOLES' DIMENSIONS DIVERSIFIED ACCORDING TO THE USE
- PERFECTLY HEAT-RESISTANT UP TO 220°C (430°F)
- DISHWASHER SAFE: HYGIENICALLY GUARANTEED



Paletta liscia nylon & fiberglass

Design by Michele Capuani

Nylon & fiberglass lifter	Cod.	L x W cm	L cm
	15740000	9,5 x 11	35



Paletta forata nylon & fiberglass

Design by Michele Capuani

Nylon & fiberglass perforated lifter	Cod.	L x W cm	L cm
	15740100	9,5 x 11	35



Paletta hamburger nylon & fiberglass

Design by Michele Capuani

Nylon & fiberglass hamburger lifter	Cod.	L x W cm	L cm
	15740200	9 x 13	34



Cucchiaino nylon & fiberglass

Nylon & fiberglass spoon	Cod.	L cm	Col.	Box
	155002	34	○	12
	155007	34	●	12



Cucchiaino forato nylon & fiberglass

Nylon & fiberglass draining spoon	Cod.	L cm
	155107	34





Spatola angolare

Design by Michele Capuani

Angular spatula

Cod.	L cm
240010	10
240022	22
240026	26
240030	30
240036	36



Spatola angolare appuntita

Design by Michele Capuani

Tapered point angular spatula

Cod.	L cm
240011	11



Spatola dritta

Design by Michele Capuani

Spatula

Cod.	L cm
240112	12
240115	15
240120	20
240122	22
240126	26
240130	30
240136	36



Spatola triangolare

Design by Michele Capuani

Triangle spatula

Cod.	W x L cm
240208	8 x 12
240210	10 x 12
240212	12 x 12



Spatola forata

Design by Michele Capuani

Perforated spatula

Cod.	W x L cm
240300	7,5 x 16



Spatola per hamburger

Design by Michele Capuani

Hamburger turner

Cod.	W x L cm
240400	7 x 24
240401	14 x 19



Spatola per pizza

Design by Michele Capuani

Pizza turner

Cod.	W x L cm
240501	9 x 15,5



Tagliapasta

Design by Michele Capuani

Dough cutter

Cod.	W x L cm
240600	16 x 12





Raschia Design by Michele Capuani
 Scraper

Cod.	W x L cm
240601	12 x 9,5
240640	15 x 7,5



Raschia Design by Michele Capuani
 Scraper

Cod.	W x L cm
240700	15 x 6



Tronchetto tagliapizza Design by Michele Capuani
 Pizza cutter

Cod.	W x L cm
240800	14 x 6



Rotella tagliapizza Design by Michele Capuani
 Pizza wheel cutter

Cod.	Ø cm
241106	5,5
241110	10



Paletta pizza ovale forata Design by Michele Capuani
 Oval perforated pizza turner

Cod.	W x L cm
240900	18 x 22



Paletta pizza ovale Design by Michele Capuani
 Oval pizza turner

Cod.	W x L cm
240901	18 x 22



Paletta pizza triangolare forata Design by Michele Capuani
 Triangle perforated pizza turner

Cod.	W x L cm
241000	12 x 16



Paletta pizza triangolare Design by Michele Capuani
 Triangle pizza turner

Cod.	W x L cm
241001	12 x 16

Grattugia inox manico antiscivolo



UNIVERSALE ALL-IN-ONE

Stainless steel grater non slip handle

Cod.	L x W cm	L cm
160145	2,5 x 20	33



Grattugia inox manico antiscivolo



EXTRA SPESSA EXTRA COARSE

Stainless steel grater non slip handle

Cod.	L x W cm	L cm
160151	3,5 x 22	38,5



Grattugia inox manico antiscivolo



SEMI FINE MEDIUM COARSE

Stainless steel grater non slip handle

Cod.	L x W cm	L cm
160152	3,5 x 22	38,5



Grattugia inox manico antiscivolo



FINE FINE

Stainless steel grater non slip handle

Cod.	L x W cm	L cm
160153	3,5 x 22	38,5



Grattugia inox manico antiscivolo



FINE FINE

Stainless steel grater non slip handle

Cod.	L x W cm	L cm
160170	6,5 x 13,5	31,5



Grattugia inox manico antiscivolo



SPESSA COARSE

Stainless steel grater non slip handle

Cod.	L x W cm	L cm
160171	6,5 x 13,5	31,5



Grattugia inox manico antiscivolo



MEDIA RIBBON

Stainless steel grater non slip handle

Cod.	L x W cm	L cm
160172	6,5 x 13,5	31,5



Grattugia inox manico antiscivolo



SCAGLIE GRANDI LARGE SHAVER

Stainless steel grater non slip handle

Cod.	L x W cm	L cm
160173	6,5 x 13,5	31,5



Grattugia inox manico antiscivolo



ULTRA SPESSA ULTRA COARSE

Stainless steel grater non slip handle

Cod.	L x W cm	L cm
160174	6,5 x 13,5	31,5



- 9 DIFFERENTI TIPI DI LAMA PER COPRIRE OGNI ESIGENZA
- LAME IN ACCIAIO INOX CON MASSIMA EFFICACIA DI TAGLIO
- MANICO ERGONOMICO IN MATERIALE ANTISCIVOLO
- PIEDINO D'APPOGGIO IN GOMMA E CUSTODIA PARALAMA DI SICUREZZA
- 9 DIFFERENT BLADES TO FULLFILL EVERY NEED
- STAINLESS STEEL BLADES WITH FLAWLESS PRECISION
- ERGONOMIC HANDLE WITH NON-SLIP GRIP
- RUBBER FEET AND BLADE COVER FOR YOUR SAFETY



LE LAME THE BLADES

UNIVERSALE ALL-IN-ONE

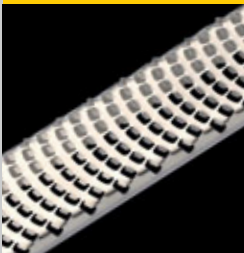

IDEALE PER:
AGRUMI,
FORMAGGIO,
ZENZERO,
CIOCCOLATO,
TARTUFO,
FRUTTA SECCA

BEST FOR:
CITRUS FRUITS,
CHEESE,
CHOCOLATE,
GINGER, TRUFFLE,
DRIED FRUIT

EXTRA SPESSE EXTRA COARSE

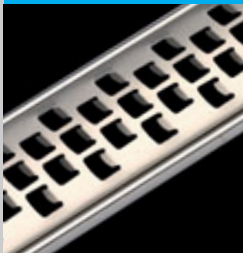

IDEALE PER:
MELE, PATATE,
BURRO,
FORMAGGIO,
ZUCCHINE,
CAROTE,
FRUTTA SECCA

BEST FOR:
APPLES, CARROTS,
POTATOES,
CHEESE, BUTTER,
ZUCCHINI,
DRIED FRUIT

SEMI FINE MEDIUM COARSE



IDEALE PER:
FORMAGGIO,
ZENZERO,
PEPERONCINO,
COCCO,
CIOCCOLATO

BEST FOR:
CHEESE,
CHILI PEPPER,
GINGER,
COCONUT,
CHOCOLATE

FINE FINE



IDEALE PER:
AGRUMI,
FORMAGGIO,
AGLIO,
PEPERONCINO,
CANNELLA,
FRUTTA SECCA

BEST FOR:
CITRUS FRUITS,
CHEESE, GARLIC,
CHILI PEPPER,
CINNAMON,
DRIED FRUIT

FINE FINE

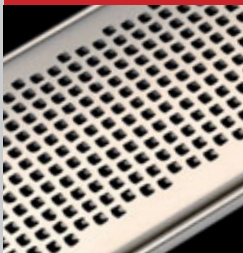

IDEALE PER:
AGRUMI,
AGLIO,
FORMAGGIO,
PEPERONCINO,
CANNELLA,
FRUTTA SECCA

BEST FOR:
CITRUS FRUITS,
CHEESE, GARLIC,
CHILI PEPPER,
CINNAMON,
DRIED FRUIT

SPESSE COARSE

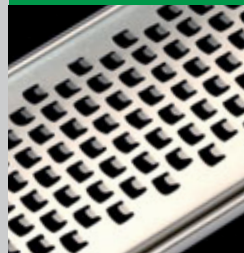

IDEALE PER:
COCCO,
CAROTE,
ZENZERO,
FRUTTA SECCA,
FORMAGGIO

BEST FOR:
CHEESE,
CARROTS,
GINGER,
COCONUT,
DRIED FRUIT

MEDIA RIBBON



IDEALE PER:
FORMAGGIO,
MELE, BURRO,
ZUCCHINE,
CAROTE,
CIOCCOLATO,

BEST FOR:
CHEESE,
CHOCOLATE,
APPLES,
CARROTS,
ZUCCHINI,
BUTTER

SCAGLIE GRANDI LARGE SHAVER



IDEALE PER:
TARTUFO,
ZUCCHINE
CIOCCOLATO,
FORMAGGIO,
BURRO

BEST FOR:
TRUFFLE,
ZUCCHINI
CHOCOLATE,
CHEESE,
BUTTER

ULTRA SPESSE ULTRA COARSE

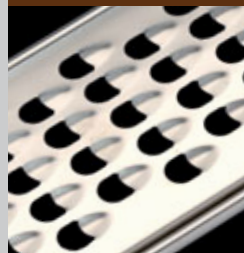

IDEALE PER:
ZUCCHINE,
BURRO,
CIOCCOLATO,
FORMAGGIO,
TARTUFO

BEST FOR:
CHEESE,
BUTTER,
ZUCCHINI,
CHOCOLATE,
TRUFFLE



Grattugia inox

Stainless steel grater	Cod.	L cm
	160109	9
	160113	13
	160116	16



Grattugia quattro lati

Grater four side	Cod.	L x W cm	H cm
	160300	8 x 6	18

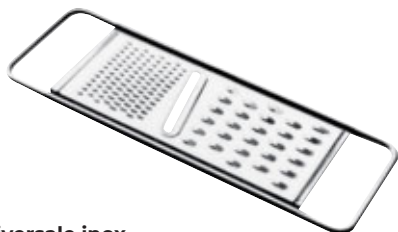

Grattugia universale inox

Stainless steel universal grater	Cod.	L x W cm
	160200	11 x 28



Frusta inox 8 fili professionale senza anello

Professional whisk without ring	Cod.	L cm
	160625	25
	160630	30

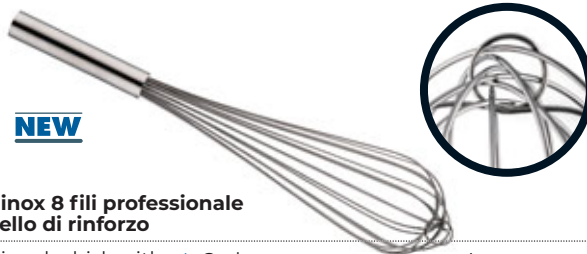

NEW

Frusta inox 8 fili professionale con anello di rinforzo

Professional whisk with reinforcement ring	Cod.	L cm
	160530	30
	160535	35
	160540	40
	160545	45
	160550	50
	160560	60



Guanto super rinforzato

Extra reinforced gloves	Cod.	Range
	161800	fino a 240°C



Coppia guanti rinforzati

Professional reinforced gloves	Cod.	Range
	161900	fino a 180°C



Coppia manopole da forno polso lungo in pelle ovina

Pair of professional reinforced gloves in kid leather	Cod.	Range
	162001	fino a 250°C





Riga limone

Lemon grater

Cod. 163400 L cm 14



Arriccia burro

Butter-curler

Cod. 163900 L cm 16



Decora limone

Lemon decorator

Cod. 163500 L cm 14,5



Scavino 2 coppe

Melon baller-double

Cod. 164100 L cm 16,5



Coltello per pelare

Peeling knife

Cod. 163600 L cm 14,5



Scavino 1 coppa

Melon baller

Cod. 164200 L cm 13



Sbuccia arancia

Orange peeler

Cod. 163700 L cm 14,5



Sbucciaverdure ad archetto

Vegetable peeler

Cod. 164400 L cm 12,5



Levator solo

Apple corer

Cod. 163800 L cm 17,5





Batticarne a pugno inox

Solid stainless steel meat beater	Cod.	W kg
	165310	1
	165315	1,5
	165320	2
	165325	2,5



Gancio girevole inox

Swivel stainless steel hook with balls on both sides	Cod.	L x W mm	Box
	165621	210 x 9	15
	165624	240 x 10	15
	165627	270 x 12	15
	165650	500 x 12	15



Batticarne a due tagli inox

Stainless steel meat beater - 2 cuts	Cod.	W kg
	165400	1,1



Gancio fisso una punta inox

Standard stainless steel hook 1 point	Cod.	L x W mm	Box
	165706	60 x 3	100
	165808	80 x 4	50
	165810	100 x 4	50
	165912	120 x 5	10
	165914	140 x 5	10
	166016	160 x 6	10
	166018	180 x 6	10
	166218	180 x 8	10
	166530	300 x 12	5



Batticarne a paletta inox

Stainless steel round ladle-type meat beater with bent handle	Cod.	W kg
	165500	1



Gancio ad ancora inox 1 punta

Stainless steel anchor-type hook 1 point	Cod.	L x W mm	Box
	166707	130 x 7	10



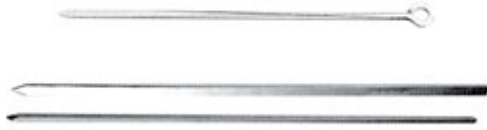

Spiedini inox

Stainless steel skewer	Cod.	L x W mm	Box
	166820	200 x 3	6
	166825	250 x 3	6
	166830	300 x 3	6
	166920	200 x 4	6
	166925	250 x 4	6
	166930	300 x 4	6

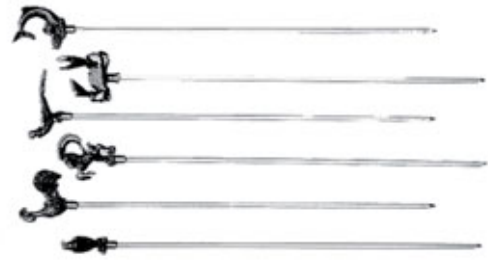

Set di spiedini inox con decoro animale

Set of stainless steel skewers with animal decoration	Cod.	L x W mm
	167000	300 x 30



Sega per ossa inox fissaggio rapido

Stainless steel saw, quick-fit	Cod.	L cm	Box
	167145	45	3
	167150	50	3



Ricambio lama sega per ossa fiss. rapido

Saw blade	Cod.	L cm	Box
	167240	40	3
	167245	45	3
	167250	50	3
	167255	55	3



Morsa prosciutto base in legno

Ham vice	Cod.
	167300



Ceppo inox con piano in plastica piedini inox antiscivolo

Stainless steel chopping block with plastic top	Cod.	L x W cm	H cm
	167440	40 x 40	90
	167450	50 x 50	90
	167460	60 x 60	90





**Portavivande per frigorifero
(senza coperchio)**

Food carrier (lid not included)	Cod.	L x W cm	H cm
	170000	9,5 x 9,5	6
	170200	9,5 x 19,5	6
	170400	19,5 x 19,5	6
	170600	20 x 29	7



Coperchio per portavivande per frigorifero

Lid for food carrier	Cod.	L x W cm	Per/For
	170100	9,5 x 9,5	170000
	170300	9,5 x 19,5	170200
	170500	19,5 x 19,5	170400
	170700	20 x 29	170600



**PIATTI ESPOSITORI IN ACCIAIO INOX:
PRATICI E PROFESSIONALI**

STAINLESS STEEL DISPLAY TRAYS:
PRACTICAL AND PROFESSIONAL

- ELEVATA RESISTENZA ALLA CORROSIONE
 - FACILITÀ DI PULIZIA E LUNGA DURATA NEL TEMPO
 - GARANZIA DI MASSIMA IGIENICITÀ
 - TOTALMENTE PRODOTTI IN ITALIA
 - IDEALI PER ESPORRE CIBI SIA CALDI CHE FREDDI
- HIGH RESISTANCE TO CORROSION
 - EASE OF CLEANING AND LONG-LASTING DURABILITY
 - GUARANTEE OF MAXIMUM HYGIENE,
 - ENTIRELY MANUFACTURED IN ITALY
 - IDEAL FOR DISPLAYING BOTH HOT AND COLD FOODS



**Platto espositore
per pasticceria e gastronomia**

Display tray	Cod.	L x W cm	H cm
	180114	14,5 x 21	2
	180129	29 x 21	2
	180158	58 x 21	2





Mandolina con carrello

Professional vegetable cutter with safety guard

Cod.

195100



Set lame per mandolina

Set of blades for vegetable slicer

Cod.

195500

Set per/for **195400**

195600

Set per/for **195100**

Cod. 195500

Cod. 195600



Mandolina affetta verdure

Professional vegetable cutter

Cod.

195200



Affettaverdure rotante "le rouet"

Rotating vegetable slicer "le rouet"

Cod.

195700

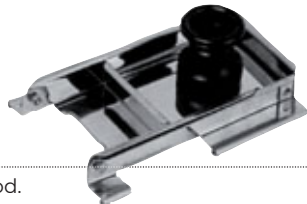

Carrello per mandolina

Safety guard

Cod.

195300



Mandolina "gourmet"

Manual vegetable slicer

Cod.

195400



Affettapane con tagliere in legno

Bread cutter with wood

Cod.

196200



Scavino pulisci pomodoro

Tomato seeds remover

Cod.

195900



Grattugia fine

Grater

Cod.

196500





Coltello cuoco

Chef knife	Cod.	L cm
	8115-1461F12	15
	8115-1461F05	21
	8115-1461F60	23
	8115-1461F61	25



Coltello trinciante

Carving knife	Cod.	L cm
	8115-1461F04	21
	8115-1461F57	25



Coltello filettare

Fillet knife	Cod.	L cm
	8115-1461F09	18



Coltello multiuso

Utility knife	Cod.	L cm
	8115-1461F03	13



Coltello multiuso lama larga

Utility knife	Cod.	L cm
	8115-1461F70	14



Spelucchino

Paring knife	Cod.	L cm
	8115-1461F01	9



Spelucchino lama curva

Curved paring knife	Cod.	L cm
	8115-1461F17	8



LA TRADIZIONE ORIENTALE NEL TRATTAMENTO DELLE LAME SI UNISCE ALLA ROBUSTEZZA DELL'ACCIAIO TEDESCO
ORIENTAL TRADITION IN THE TREATMENT OF BLADE JOINS THE STRENGTH OF GERMAN STEEL

PREMIUM SERIES COLTELLI FORGIATI FORGED KNIVES



L'acciaio dei coltelli Atlantic Chef è acciaio tedesco 1.4116-X50 Cr Mo V15. La combinazione di Carbonio, Cromo, Molibdeno, Vanadio e altri materiali, conferisce alla lama una durezza di HRC 56' e oltre, fornendo rigidità ed elasticità al tempo stesso, aumentando la resistenza alla corrosione e ottimizzando l'efficacia di taglio. La levigatura manuale garantisce infine la lunga durata del filo della lama, una facile manutenzione e una veloce riaffilatura. I coltelli Atlantic Chef sono inoltre tutti certificati NSF® International.

PER GARANTIRE RESISTENZA E DURATA NEL TEMPO, MANICO E LAMA SONO FORGIATI A PARTIRE DA UN UNICO PEZZO DI ACCIAIO. CIÒ FORNISCE INOLTRE A OGNI SINGOLO PEZZO UNA BILANCIATURA PERFETTA CHE NE FACILITA L'UTILIZZO E RIDUCE LA FATICA.

HANDLE AND BLADE ARE FORGED FROM A SINGLE PIECE OF STEEL, WHICH PROVIDES STRENGTH AND A LONG USEFUL LIFE. ADDITIONALLY, EACH KNIFE IS PERFECTLY BALANCED: THIS HELPS ITS EASY USE AND REDUCES EFFORT.

MANICI IN DUPONT™ DELRIN® POM, UNA RESINA ACETALICA CON CARATTERISTICHE UNICHE DI RIGIDITÀ E RESISTENZA AGLI URTI RIPETUTI, ALL'ABRASIONE E ALL'UMIDITÀ. SONO PERFETTAMENTE ADERENTI AL MANICO E AI RIVETTI, OFFRENDO MASSIMA IGIENICITÀ.

HANDLES ARE MADE OF DUPONT™ DELRIN® POM, AN ACETAL RESIN FEATURING UNIQUE CHARACTERISTICS OF STIFFNESS AND RESISTANCE TO REPEATED SHOCKS, ABRASION AND HUMIDITY. THEY PERFECTLY STICK TO THE HANDLE AND RIVETS, ASSURING TOP HYGIENE.



Coltello Santoku

Santoku knife

Cod.	L cm
8115-1461F38	18



Coltello arrosto

Slicing knife

Cod.	L cm
8115-1461F109	28



Coltello Usuba

Usuba knife

Cod.	L cm
8115-1461F46	18



Forchettone curvo

Carving fork - curved

Cod.	L cm
8115-1461F11	16



Coltello disosso

Boning knife

Cod.	L cm
8115-1461F10	15



Coltello pane

Bread knife

Cod.	L cm
8115-1461F06	21
8115-1461F53	23



Coltello pomodoro lama dentata

Tomato knife - serrated edge

Cod.	L cm
8115-1461F14	14



EFFICIENT SERIES COLTELLI STAMPATI
STAMPED KNIVES



Atlantic Chef uses German Steel 1.4116-X50 Cr Mo V15, which consists of Carbon, Chromium, Vanadium, Molybdenum and several other materials. After hardening/tempering, grinding, sharpening and some other major processes, the hardness of the blades can reach as high as HRC 56' and above. Knives are simultaneously strong and flexible, and this increases their cutting power and resistance to corrosion. The hand-honed razor sharp blade edge also offers long lasting sharpness, easy edge maintenance and rapid re-sharpening features. All the knives are certified by NSF® International.

GRAZIE A PROCESSI PRODUTTIVI AVANZATI E DI MASSIMA PRECISIONE, L'ACCOUPLAMENTO FRA MANICO E LAMA RISULTA SEMPRE PERFETTAMENTE COMPATTO, GARANTENDO IGIENE E SOLIDITÀ OTTIMALI.

THANKS TO ADVANCED AND PRECISE PRODUCTIVE PROCESSES THE JOINING BETWEEN HANDLE AND BLADE ARE ALWAYS PERFECT AND SOLID.

I MANICI SONO REALIZZATI CON LA COMBINAZIONE DI SANTOPRENE® (UNO SPECIALE ELASTOMERO DALLE DOTI ANTISCIVOLO) E POLIPROPILENE. OFFRONO PRESA SICURA, TOTALE CONTROLLO DEL COLTELLO E MASSIMA ROBUSTEZZA.

THE HANDLES, MADE BY A COMBINATION OF SANTOPRENE® (A SPECIAL ELASTOMER WITH NON-GRIP FEATURES) AND POLYPROPYLENE, OFFER NON-SLIP ERGONOMIC GRIP, TOTAL CONTROL OF THE KNIFE AND MAXIMUM STRENGTH.



Coltello cuoco

Chef knife



Cod.	L cm	Col.
8100-8321T12	15	●
8100-8321T05	21	●
8100-8321T05BL	21	●
8100-8321T05G	21	●
8100-8321T05R	21	●
8100-8321T05W	21	○
8100-8321T05Y	21	●
8100-8321T60	23	●
8100-8321T61	25	●
8100-8321T61BL	25	●
8100-8321T61BR	25	●
8100-8321T61G	25	●
8100-8321T61R	25	●
8100-8321T61W	25	○
8100-8321T61Y	25	●
8100-8321T62	30	●
8100-8321T62BL	30	●
8100-8321T62BR	30	●
8100-8321T62G	30	●
8100-8321T62R	30	●
8100-8321T62W	30	○
8100-8321T62Y	30	●



Coltello multiuso lama dentata

Utility knife
Serrated edge

Cod.	L cm
8150-8321SS132	13



Coltello cuoco lama dentata

Chef knife
Serrated edge

Cod.	L cm
8100-8321T137	21
8100-8321T143	23
8100-8321T144	25



Coltello cuoco lama obliqua

Wide chef knife

Cod.	L cm
8100-8321T115	21



PER ALCUNI SPECIFICI MODELLI È PREVISTA LA DISPONIBILITÀ ANCHE DI MANICI COLORATI IN ACCORDO CON LA NORMATIVA HACCP

SOME SPECIFIC ITEMS ARE AVAILABLE ALSO WITH COLOURED HANDLES ACCORDING TO HACCP REGULATIONS



Coltello multiuso

Utility knife

Cod.	L cm
8100-8321T70	15



Coltello filettare - flessibile

Fillet knife - flexible

Cod.	L cm	Col.
8100-8321T09	18	●
8100-8321T71	21	●
8100-8321T71BL	21	●



Coltello Santoku

Santoku knife

Cod.	L cm
8100-8321T38	19



Coltello Usuba

Usuba knife

Cod.	L cm
8100-8321T46	18





Coltello disosso

Boning knife

Cod.	L cm	Col.
8100-8321T10	15	●
8100-8321T10BL	15	●
8100-8321T10R	15	●
8100-8321T10Y	15	●



Spelucchino

Paring knife

Cod.	L cm	Col.
8150-8321SS01	8	●
8150-8321SS01G	8	●
8150-8321SS01W	8	○
8150-8321SS02	11	●



Coltello disosso - Flessibile

Boning knife - Flexible

Cod.	L cm
8100-8321T66	15



Spelucchino lama dentata

Paring knife
serrated edge

Cod.	L cm	Col.
8150-8321SS36	8	●
8150-8321SS36G	8	●
8150-8321SS36W	8	○



Coltello disosso stretto

Wide boning knife

Cod.	L cm
8100-8321T133	13



Spelucchino verdure lama curva

Curved paring knife

Cod.	L cm	Col.
8150-8321SS17	7	●
8150-8321SS17G	7	●
8150-8321SS17W	7	○



Coltello disosso stretto - Flessibile

Narrow boning knife
Flexible

Cod.	L cm
8100-8321T69	15



Coltello tavola

Utility knife - Round top

Cod.	L cm	Col.
8150-8321SS03	11	●
8150-8321SS03G	11	●
8150-8321SS03W	11	○



Coltello disosso curvo

Curved boning knife

Cod.	L cm
8100-8321T64	15



Coltello arrosto

Slicer knife

Cod.	L cm
8100-8321T136	23







Forchettone curvo

Carving fork - Curved

Cod.	L cm
8100-8321T11	21



Forchettone dritto

Carving fork - Straight

Cod.	L cm
8100-8321T28	18



Coltello salmone

Salmon knife

Cod.	L cm
8100-8321T19	26



Coltello salmone lama alveolata

Salmon knife
granton edge

Cod.	L cm
8100-8321T77	26



Coltello prosciutto

Slicing knife

Cod.	L cm
8100-8321T108	30



Coltello prosciutto lama alveolata

Slicing knife
granton edge

Cod.	L cm	Col.
8100-8321T73	28	●
8100-8321T73W	28	○
8100-8321T68	36	●



Coltello formaggio punta quadra

Cheese slicer

Cod.	L cm
8100-8321T135	31



Coltello pane

Bread knife

Cod.	L cm	Col.
8100-8321T06	21	●
8100-8321T06W	21	○
8100-8321T134	25	●



Coltello pane con scalino

Offset bread knife

Cod.	L cm
8100-8321T15	21



Coltello pane con scalino e punta arrotondata

Offset bread knife
Round top

Cod.	L cm
8100-8321T106	21



Coltello pane lama inclinata

Wide bread knife

Cod.	L cm
8100-8321T59	25



Coltello panettiere

Slicing knife
Serrated edge

Cod.	L cm	Col.
8100-8321T72	28	●
8100-8321T72W	28	○
8100-8321T100	30	●
8100-8321T101	36	●





Coltello dolce

Cake knife	Cod.	L cm
	8100-8320T30	40
	8100-8320T31	45



Forbici

Scissors	Cod.
	8155-9300T01



Coltello dolce lama dentata

Cake knife Serrated edge	Cod.	L cm
	8100-8320T32	40
	8100-8320T40	45



Custodia

Knife guard	Cod.	Per/For
	8190-8321SS02	8150-8321SS02
	8190-8321SS132	8150-8321SS132
	8190-8321SS17	8150-8321SS17
	8190-8321T09	8100-8321T09
	8190-8321T100	8100-8321T100
	8190-8321T133	8100-8321T133
	8190-8321T134	8100-8321T134
	8190-8321T135	8100-8321T135
	8190-8321T136	8100-8321T136
	8190-8321T60	8100-8321T60



Set decorazione cocktail - 7 pezzi

Cocktail decoration set 7 pieces	Cod.
	8151-9100G7001



Acciaino tondo

Sharpening steel	Cod.	L cm
	8153-TD1312	30



Set per intaglio e decorazione - 8 pezzi

Carving tool set 8 pieces	Cod.
	8151-9100G8001



Affilacoltelli manuale

Hand held knife sharpener	Cod.
	8154-SH001



MASSIMA EFFICACIA E IGIENE PERFETTA
MAX EFFICIENCY AND PERFECT HYGIENE

I taglieri in Polietilene HD sono adatti a tutti gli ambiti HACCP.
Grazie alla loro superficie, totalmente liscia, e alla totale assenza di coloranti garantiscono massima efficacia d'uso e perfetta igiene.
Nella confezione inoltre sono compresi 7 fermi e 5 viti di montaggio per classificare a vostro piacere l'utilizzo del tagliere secondo la normativa HACCP.

These HD polyethylene cutting boards are suitable for all HACCP areas.

Max efficiency and perfect hygiene guaranteed thanks to the super smooth surface and total absence of colouring.

Each pack also contains 7 coloured stoppers and 5 screws letting you colour code each board for use in a specific HACCP area.



1
MONTARE IL PRIMO FERMO (SEMPRE BIANCO)
INSERT THE FIRST STOPPER (ALWAYS WHITE)



2
MONTARE IL SECONDO FERMO (COLORE HACCP)
INSERT THE SECOND STOPPER (HACCP COLOUR)



Tagliere in polietilene HD

Polyethylene cutting board	Cod.	L x W cm	H cm
	208000	40 x 30	2
	208100	50 x 30	2
	208200	50 x 40	2
	208300	60 x 40	2
	208400	70 x 40	2



209000



209099

Pialletto e fermi per taglieri in polietilene

Scraper and stoppers for polyethylene cutting boards	Cod.	Box
	209000	
	209099	6



Cod. 209099

CARNI CRUDE RAW MEAT	PANE E FORMAGGI BREAD AND CHEESE	CARNI COTTE COOKED MEAT	INSALATA E FRUTTA VEGETABLES AND FRUITS	VERDURE COTTE COOKED VEGETABLES	PESCE FISH



MAX. MM 146

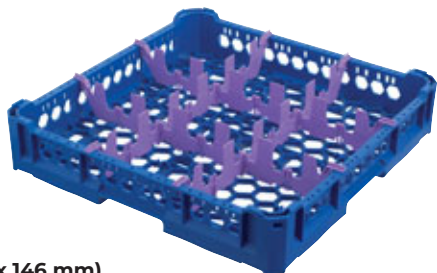
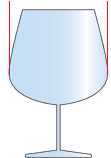

Cestello bicchieri a 9 scomparti (146 x 146 mm)

Glass rack with 9 compartments (146 x 146 mm)	Cod.	L x W cm	H mm	Box
	210000	50 x 50	< 65	2
	210001	50 x 50	66-120	
	210002	50 x 50	121-250	
	210003	50 x 50	251-340	



MAX. MM 88

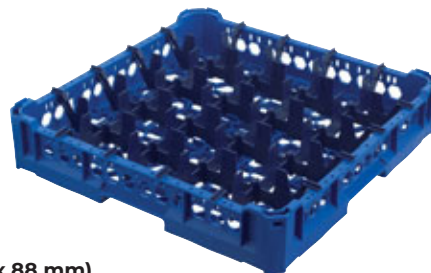

Cestello bicchieri a 25 scomparti (88 x 88 mm)

Glass rack with 25 compartments (88 x 88 mm)	Cod.	L x W cm	H mm	Box
	210020	50 x 50	< 65	2
	210021	50 x 50	66-120	
	210022	50 x 50	121-250	
	210023	50 x 50	251-340	



MAX. MM 113

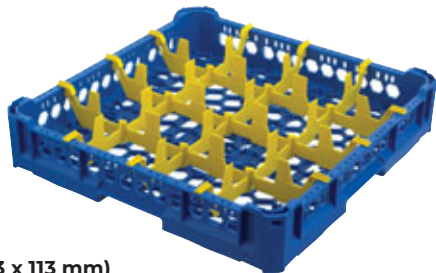
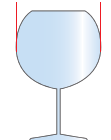

Cestello bicchieri a 16 scomparti (113 x 113 mm)

Glass rack with 16 compartments (113 x 113 mm)	Cod.	L x W cm	H mm	Box
	210010	50 x 50	< 65	2
	210011	50 x 50	66-120	
	210012	50 x 50	121-250	
	210013	50 x 50	251-340	



MAX. MM 73

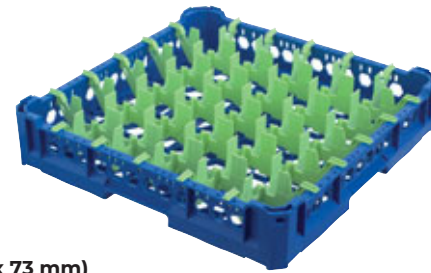
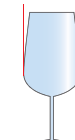

Cestello bicchieri a 36 scomparti (73 x 73 mm)

Glass rack with 36 compartments (73 x 73 mm)	Cod.	L x W cm	H mm	Box
	210030	50 x 50	< 65	2
	210031	50 x 50	66-120	
	210032	50 x 50	121-250	
	210033	50 x 50	251-340	



PERSONALIZZAZIONE FACILE E VELOCE
QUICK AND EASY PERSONALISING

I cestelli bicchieri consentono una facile e veloce personalizzazione, adattandosi alle vostre esigenze di lavaggio. La presenza di elementi scorrevoli all'interno delle guide fissate ai quattro angoli permette di variare l'altezza totale del cestello.

Basta sollevare l'elemento superiore (l'estensione con la griglia a scomparti) fino all'altezza desiderata. (Fig.1)

Inserite i 4 bottoni di fissaggio in dotazione per bloccare i cursori di scorrimento e fissare l'estensione. (Fig. 2)

Il cestello è pronto per essere riempito con i bicchieri da mandare in lavaggio. (Fig. 3)

Se una volta ultimato il processo di lavaggio necessitate una diversa altezza del cestello non dovete fare altro che rimuovere (e sostituire) i bottoni di fissaggio, i cursori saranno nuovamente liberi di scorrere permettendovi una differente personalizzazione dell'altezza del cestello.

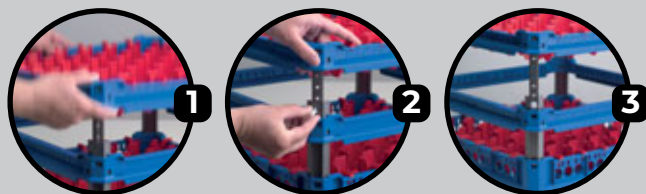

These glass racks can be quickly and easily personalised, letting you adapt to your specific needs each time. Special elements running inside the fixed guides at the four corners let you change the total height of your rack whenever necessary.

Simply lift the top element (extender with divider insert) to the height you want. (Fig. 1)

Insert the 4 fixing buttons provided to stop the sliders and so fix the extender. (Fig. 2)

Your rack is ready to be filled with glasses to be washed. (Fig. 3)

If, after washing, you need to change the height for other glasses, simply remove (and replace) the buttons: the sliders are now freed for you to adjust the height (insert the buttons at the new height).

MAX. MM 63

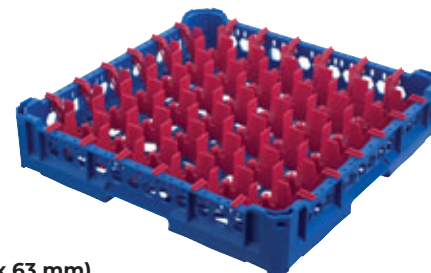
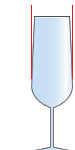

Cestello bicchieri a 49 scomparti (63 x 63 mm)

Glass rack with 49 compartments (63 x 63 mm)	Cod.	L x W cm	H mm	Box
	210040	50 x 50	< 65	2
	210041	50 x 50	66-120	
	210042	50 x 50	121-250	
	210043	50 x 50	251-340	



1

- CESTELLO BASE 50X50 CM CON GRIGLIA A 9-16-25-36-49 SCOMPARTI
- 50X50 CM RACK BASE AND DIVIDER INSERT WITH 9-16-25-36-49 COMPART

2

- CESTELLO BASE 50X50 CM CON GRIGLIA A 9-16-25-36-49 SCOMPARTI
- ESTENSIONE 50X50 CM CON GRIGLIA A 9-16-25-36-49 SCOMPARTI
- 50X50 CM RACK BASE AND DIVIDER INSERT WITH 9-16-25-36-49 COMPART
- 50X50 CM EXTENDER AND DIVIDER INSERT WITH 9-16-25-36-49 COMPART



Cestello tazze e terrine

Cup/pan rack Cod. L x W cm Box
 211000 50 x 50 2



Cestello vassoi aperto

Open tray rack Cod. L x W cm Box
 211003 50 x 50 2



Cestello piatti-vassoi

Plate/tray rack Cod. L x W cm Box
 211001 50 x 50 2

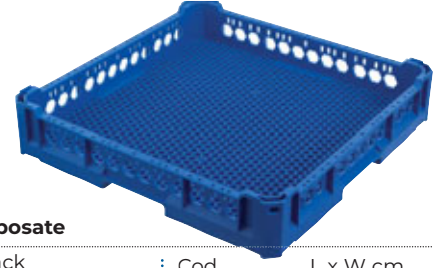

Cestello posate

Cutlery rack Cod. L x W cm Box
 211004 50 x 50 2

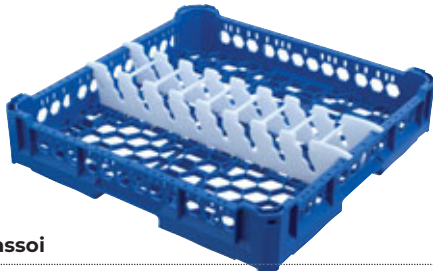

Cestello vassoi

Tray rack Cod. L x W cm Box
 211002 50 x 50 2



Carrello per cestelli

Rack trolley Cod. 219000



CONFEZIONE
 20
 PEZZI/PIECES

Bottoni fissaggio di ricambio

Spare fixing buttons Cod. 219900



UNICO CESTELLO, DIFFERENTI SOLUZIONI

SINGLE RACK, DIFFERENT SOLUTIONS

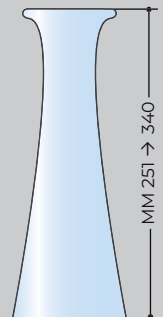
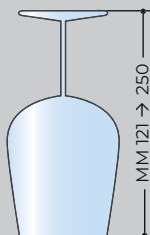
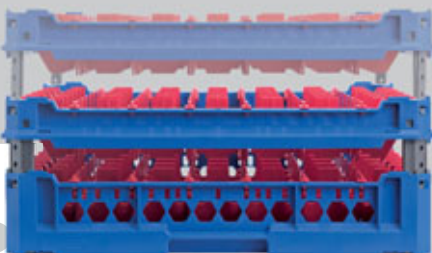

- CESTELLO BASE 50X50 CM CON GRIGLIA A 9-16-25-36-49 SCOMPARTI
- ESTENSIONE 50X50 CM CON GRIGLIA A 9-16-25-36-49 SCOMPARTI
- BOTTONI PER FISSAGGIO
- 50X50 CM RACK BASE AND DIVIDER INSERT WITH 9-16-25-36-49 COMPART
- 50X50 CM EXTENDER AND DIVIDER INSERT WITH 9-16-25-36-49 COMPART
- FIXING BUTTONS

- CESTELLO BASE 50X50 CM CON GRIGLIA A 9-16-25-36-49 SCOMPARTI
- ESTENSIONE 50X50 CM CON GRIGLIA A 9-16-25-36-49 SCOMPARTI
- ESTENSIONE APERTA 50X50 CM
- BOTTONI PER FISSAGGIO
- 50X50 CM RACK BASE AND DIVIDER INSERT WITH 9-16-25-36-49 COMPART
- 50X50 CM EXTENDER AND DIVIDER INSERT WITH 9-16-25-36-49 COMPART
- OPEN 50X50 CM EXTENDER
- FIXING BUTTONS

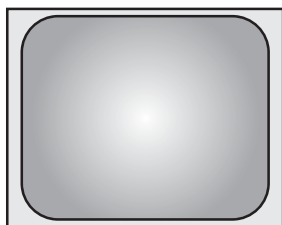

Bacinella GN 2/1 in acciaio inox

Gastronorm container 2/1 in stainless steel	Cod.	L x W cm	H cm
	220002	65 x 53	2
	220004	65 x 53	4
	220006	65 x 53	6,5
	220010	65 x 53	10
	220015	65 x 53	15
	220020	65 x 53	20

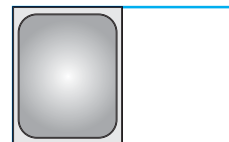

Bacinella GN 1/2 in acciaio inox

Gastronorm container 1/2 in stainless steel	Cod.	L x W cm	H cm
	220302	32,5 x 26,5	2
	220304	32,5 x 26,5	4
	220306	32,5 x 26,5	6,5
	220310	32,5 x 26,5	10
	220315	32,5 x 26,5	15
	220320	32,5 x 26,5	20



Bacinella GN 1/1 in acciaio inox

Gastronorm container 1/1 in stainless steel	Cod.	L x W cm	H cm
	220102	53 x 32,5	2
	220104	53 x 32,5	4
	220106	53 x 32,5	6,5
	220110	53 x 32,5	10
	220115	53 x 32,5	15
	220120	53 x 32,5	20



Bacinella GN 1/3 in acciaio inox

Gastronorm container 1/3 in stainless steel	Cod.	L x W cm	H cm
	220402	32,5 x 17,5	2
	220404	32,5 x 17,5	4
	220406	32,5 x 17,5	6,5
	220410	32,5 x 17,5	10
	220415	32,5 x 17,5	15
	220420	32,5 x 17,5	20

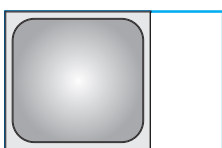

Bacinella GN 2/3 in acciaio inox

Gastronorm container 2/3 in stainless steel	Cod.	L x W cm	H cm
	220202	35,5 x 32,5	2
	220204	35,5 x 32,5	4
	220206	35,5 x 32,5	6,5
	220210	35,5 x 32,5	10
	220215	35,5 x 32,5	15
	220220	35,5 x 32,5	20

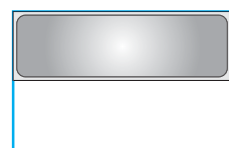

Bacinella GN 2/4 in acciaio inox

Gastronorm container 2/4 in stainless steel	Cod.	L x W cm	H cm
	222904	53 x 16,2	4
	222906	53 x 16,2	6,5
	222910	53 x 16,2	10
	222915	53 x 16,2	15



Bacinella GN 2/8 in acciaio inox

Gastronorm container 2/8 in stainless steel	Cod.	L x W cm	H cm
	224015	13 x 32,5	15

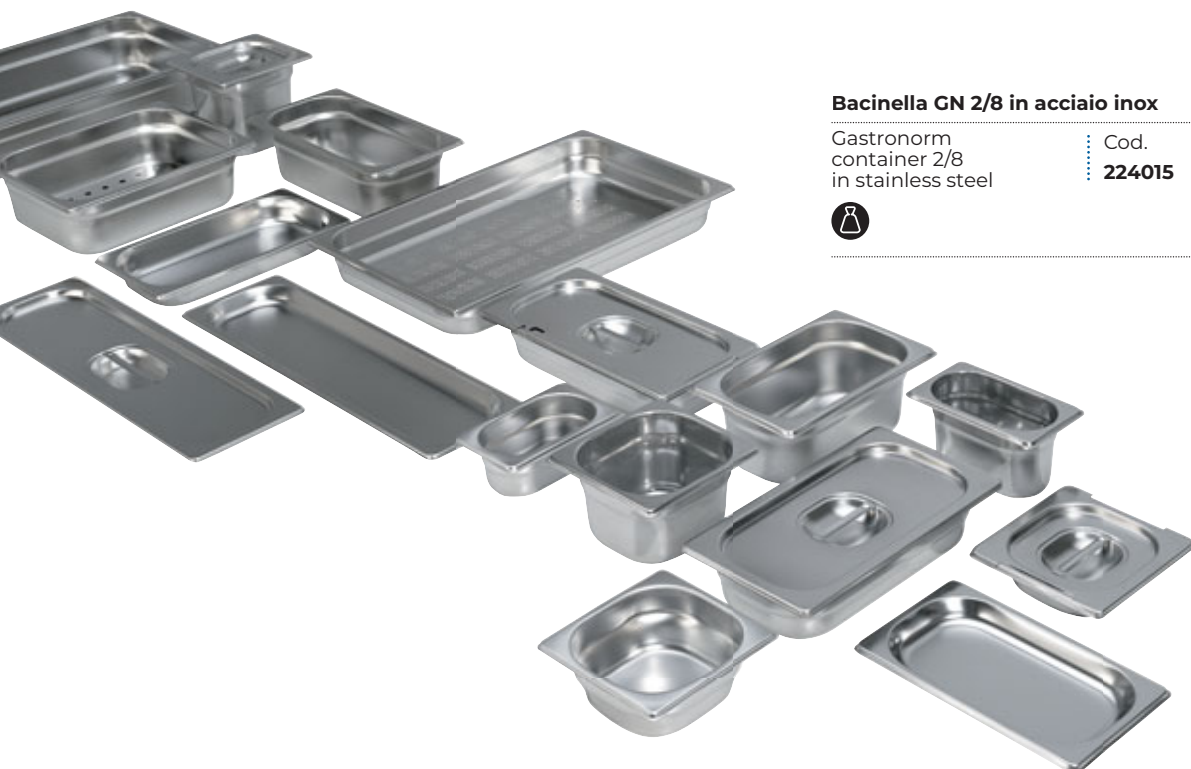



Bacinella GN 1/4 in acciaio inox

Gastronorm container 1/4 in stainless steel	Cod.	L x W cm	H cm
	220502	26,4 x 16,2	2
	220504	26,4 x 16,2	4
	220506	26,4 x 16,2	6,5
	220510	26,4 x 16,2	10
	220515	26,4 x 16,2	15
	220520	26,4 x 16,2	20



Bacinella GN 1/6 in acciaio inox

Gastronorm container 1/6 in stainless steel	Cod.	L x W cm	H cm
	220602	17,6 x 16,2	2
	220604	17,6 x 16,2	4
	220606	17,6 x 16,2	6,5
	220610	17,6 x 16,2	10
	220615	17,6 x 16,2	15
	220620	17,6 x 16,2	20



Bacinella GN 1/9 in acciaio inox

Gastronorm container 1/9 in stainless steel	Cod.	L x W cm	H cm
	220706	17,6 x 10,8	6,5
	220710	17,6 x 10,8	10



PREPARARE, CUOCERE, TRASPORTARE ED ESPORRE
PREPARE, COOK, TRANSPORT AND DISPLAY

Potete fare tutto utilizzando il medesimo contenitore evitando scomode sostituzioni.

La serie in acciaio inox 18/10 è adatta a qualunque tipo di preparazione sia a caldo che a freddo e le sue caratteristiche tecniche ne consentono l'uso in tutte le moderne apparecchiature professionali: friggitrice, forni di cottura, armadi frigoriferi ecc. Totalmente idonea al contatto con gli alimenti, secondo la normativa UE89/109, garantisce una perfetta igienicità grazie anche alla semplicità di pulizia (può andare in lavastoviglie).

You can do everything using the same container, avoiding bothersome replacements.

The series in 18/10 stainless steel is ideal for all kinds of hot and cold preparations and its technical features mean that the series can be used with all modern professional equipment: fryers, cooking ovens, refrigerated units etc. Fully suitable for contact with foodstuffs in accordance with UE89/109 Standards, it ensures perfect hygiene, thanks also to easy cleaning (it can go in the dishwasher).

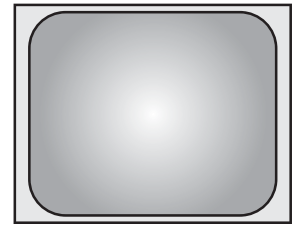

Teglia GN 2/1 in acciaio inox

Gastronorm baking pan 2/1 in stainless steel	Cod.	L x W cm	H cm
	223002	65 x 53	2
	223004	65 x 53	4
	223006	65 x 53	6,5



Teglia GN 1/1 in acciaio inox

Gastronorm baking pan 1/1 in stainless steel	Cod.	L x W cm	H cm
	220802	53 x 32,5	2
	220804	53 x 32,5	4
	220806	53 x 32,5	6,5

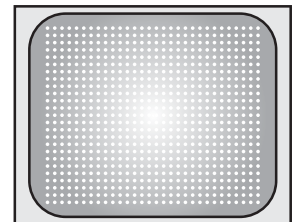

Bacinella forata GF 2/1 in acciaio inox

Gastronorm perforated container 2/1 in stainless steel	Cod.	L x W cm	H cm
	220902	65 x 53	2
	220904	65 x 53	4
	220906	65 x 53	6,5
	220910	65 x 53	10
	220915	65 x 53	15
	220920	65 x 53	20

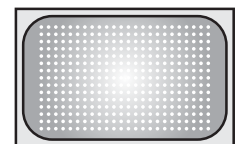

Bacinella forata GF 1/1 in acciaio inox

Gastronorm perforated container 1/1 in stainless steel	Cod.	L x W cm	H cm
	221002	53 x 32,5	2
	221004	53 x 32,5	4
	221006	53 x 32,5	6,5
	221010	53 x 32,5	10
	221015	53 x 32,5	15
	221020	53 x 32,5	20

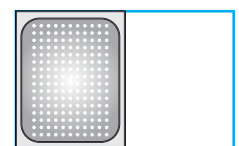

Bacinella forata GF 1/2 in acciaio inox

Gastronorm perforated container 1/2 in stainless steel	Cod.	L x W cm	H cm
	221102	32,5 x 26,5	2
	221104	32,5 x 26,5	4
	221106	32,5 x 26,5	6,5
	221110	32,5 x 26,5	10
	221115	32,5 x 26,5	15
	221120	32,5 x 26,5	20





Falso fondo forato

Gastronorm drainer plate	Cod.	GN
	221611	1/1
	221612	1/2
	221621	2/1
	221623	2/3



Coppia maniglie cascanti

Falling handles	Cod.
	221800



LA COPPIA MANIGLIE CASCANTI VIENE VENDUTA SOLTANTO IN COMBINAZIONE CON LA RELATIVA BACINELLA GASTRONORM. IL COSTO DELLE MANIGLIE È DA SOMMARSÌ AL COSTO DELLA BACINELLA.

TWO FALLING HANDLES ARE SOLD ONLY AS SET WITH THE CORRESPONDING GN FOODCONTAINER. HANDLE-PRICE HAS TO BE ADDED TO THE CONTAINER-PRICE.



Separatore

Adaptor bar	Cod.	L cm
	221726	26,5
	221732	32,5
	221753	53

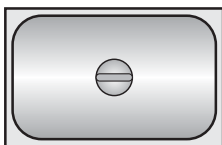

Coperchio in acciaio inox

Lid in stainless steel	Cod.	GN
	221911	1/1
	221912	1/2
	221913	1/3
	221914	1/4
	221916	1/6
	221919	1/9
	221923	2/3
	221924	2/4
	221928	2/8

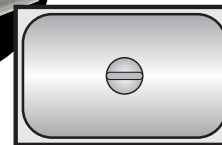

Coperchio in acciaio inox con guarnizione

Lid in stainless steel with trimming	Cod.	GN
	222011	1/1
	222012	1/2
	222013	1/3
	222014	1/4
	222016	1/6
	222023	2/3

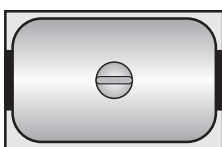

Coperchio in acciaio inox con spacco maniglie

Lid in stainless steel with notch for handles	Cod.	GN
	222111	1/1
	222112	1/2
	222113	1/3
	222116	1/6
	222123	2/3

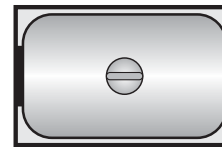

Coperchio in acciaio inox con spacco maniglie e guarnizione

Lid in stainless steel with trimming and notch for handles	Cod.	GN
	222211	1/1
	222212	1/2

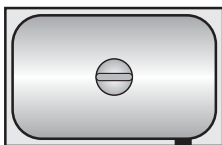

Coperchio in acciaio inox con spacco mestolo

Lid in stainless steel with notch for ladle	Cod.	GN
	222313	1/3
	222314	1/4
	222316	1/6
	222323	2/3

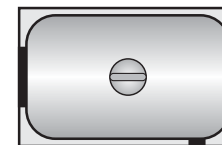

Coperchio in acciaio inox con spacco maniglie e mestolo

Lid in stainless steel with notch for handles and ladle	Cod.	GN
	222411	1/1
	222412	1/2
	222413	1/3
	222423	2/3





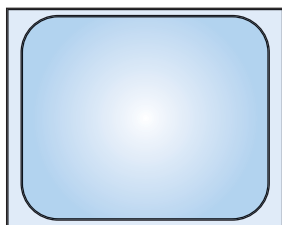

Bacinella GN 2/1 in plastica

Gastronorm container 2/1 in plastic	Cod.	L x W cm	H cm
	225020	65 x 53	20

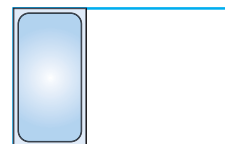

Bacinella GN 1/3 in plastica

Gastronorm container 1/3 in plastic	Cod.	L x W cm	H cm
	225406	32,5 x 17,5	6,5
	225410	32,5 x 17,5	10
	225415	32,5 x 17,5	15
	225420	32,5 x 17,5	20



Bacinella GN 1/1 in plastica

Gastronorm container 1/1 in plastic	Cod.	L x W cm	H cm
	225106	53 x 32,5	6,5
	225110	53 x 32,5	10
	225115	53 x 32,5	15
	225120	53 x 32,5	20

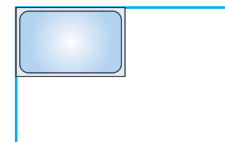

Bacinella GN 1/4 in plastica

Gastronorm container 1/4 in plastic	Cod.	L x W cm	H cm
	225506	26,4 x 16,2	6,5
	225510	26,4 x 16,2	10
	225515	26,4 x 16,2	15
	225520	26,4 x 16,2	20

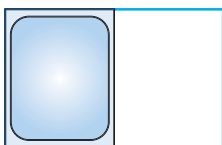

Bacinella GN 1/2 in plastica

Gastronorm container 1/2 in plastic	Cod.	L x W cm	H cm
	225306	32,5 x 26,5	6,5
	225310	32,5 x 26,5	10
	225315	32,5 x 26,5	15
	225320	32,5 x 26,5	20



Bacinella GN 1/6 in plastica

Gastronorm container 1/6 in plastic	Cod.	L x W cm	H cm
	225606	17,6 x 16,2	6,5
	225610	17,6 x 16,2	10
	225615	17,6 x 16,2	15
	225620	17,6 x 16,2	20

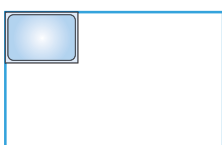

Bacinella GN 1/9 in plastica

Gastronorm container 1/9 in plastic	Cod.	L x W cm	H cm
	225706	17,6 x 10,8	6,5
	225710	17,6 x 10,8	10

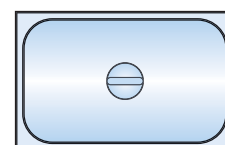

Coperchio in plastica

Lid in plastic	Cod.	GN
	226010	2/1
	226011	1/1
	226012	1/2
	226013	1/3
	226014	1/4
	226016	1/6
	226019	1/9



Falso fondo forato in plastica

Gastronorm drainer plate in plastic	Cod.	GN
	227010	2/1
	227011	1/1
	227012	1/2



Bacinella GN 1/1 in polipropilene



Gastronorm container 1/1 in polypropylene	Cod.	L x W cm	H cm
	228106	53 x 32,5	6,5
	228110	53 x 32,5	10
	228115	53 x 32,5	15
	228120	53 x 32,5	20



Bacinella GN 1/4 in polipropilene



Gastronorm container 1/4 in polypropylene	Cod.	L x W cm	H cm
	228506	26,4 x 16,2	6,5
	228510	26,4 x 16,2	10
	228515	26,4 x 16,2	15
	228520	26,4 x 16,2	20



Bacinella GN 1/2 in polipropilene

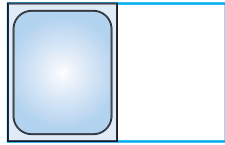

Gastronorm container 1/2 in polypropylene	Cod.	L x W cm	H cm
	228306	32,5 x 26,5	6,5
	228310	32,5 x 26,5	10
	228315	32,5 x 26,5	15
	228320	32,5 x 26,5	20



Bacinella GN 1/6 in polipropilene



Gastronorm container 1/6 in polypropylene	Cod.	L x W cm	H cm
	228606	17,6 x 16,2	6,5
	228610	17,6 x 16,2	10
	228615	17,6 x 16,2	15
	228620	17,6 x 16,2	20



Bacinella GN 1/3 in polipropilene



Gastronorm container 1/3 in polypropylene	Cod.	L x W cm	H cm
	228406	32,5 x 17,5	6,5
	228410	32,5 x 17,5	10
	228415	32,5 x 17,5	15
	228420	32,5 x 17,5	20



Bacinella GN 1/9 in polipropilene



Gastronorm container 1/9 in polypropylene	Cod.	L x W cm	H cm
	228706	17,6 x 10,8	6,5
	228710	17,6 x 10,8	10



Coperchio in polipropilene

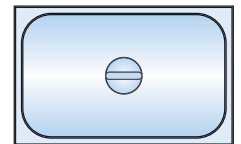

Lid in polypropylene	Cod.	GN
	229011	1/1
	229012	1/2
	229013	1/3
	229014	1/4
	229016	1/6
	229019	1/9



Falso fondo forato in polipropilene



Gastronorm drainer plate in polypropylene	Cod.	GN
	229211	1/1
	229212	1/2
	229213	1/3





PIZZA
MADE IN ITALY

PIZZERIA

LINEA DESIGN

DESIGN LINE

88

LINEA TRADIZIONE

TRADITION LINE

98

LINEA GLUTEN FREE

GLUTEN FREE LINE

100

LINEA BLUE DROP

BLUE DROP LINE

102

ACCESSORI PIZZERIA

PIZZERIA ACCESSORIES

104

SPATOLE, PALETTE E ROTELLE PIZZA

SPATULAS, TURNERS AND PIZZA WHEEL CUTTERS

109

LA NOSTRA LINEA DI PRODOTTI DEDICATA ALLA PIZZERIA SI AMPLIA CON NUOVI ARTICOLI STUDIATI PER MIGLIORARE OGNI FASE DEL VOSTRO LAVORO. ATTREZZATURE PROFESSIONALI E SOLUZIONI INNOVATIVE PENSATE PER OFFRIRE EFFICIENZA, QUALITÀ E PRATICITÀ. SCOPRITE LE NOSTRE NOVITÀ E PORTATE LA VOSTRA PIZZERIA A UN LIVELLO SUPERIORE!

OUR PIZZERIA ASSORTMENT IS EXPANDING WITH NEW ITEMS DESIGNED TO IMPROVE EVERY STAGE OF YOUR WORK. PROFESSIONAL EQUIPMENT AND INNOVATIVE SOLUTIONS CREATED TO OFFER EFFICIENCY, QUALITY, AND PRACTICALITY. DISCOVER OUR NEW PRODUCTS AND TAKE YOUR PIZZERIA TO THE NEXT LEVEL!



LINEA DESIGN DESIGN LINE

UNA GAMMA AMPIA IN CUI LA BELLEZZA DELLE FORME SPOSA L'ECCELLENZA NELLE PRESTAZIONI

A WIDE RANGE WHERE THE BEAUTY OF FORM MARRIES EXCELLENCE IN PERFORMANCE



LINEA TRADIZIONE TRADITION LINE

LA CLASSICITÀ REINTERPRETATA, RINNOVATA E AGGIORNATA PER RESTARE SEMPRE AL PASSO CON I TEMPI

CLASSIC STYLE REINTERPRETED, RENEWED AND UPDATED TO ALWAYS BE IN STEP WITH THE TIMES



LINEA GLUTEN FREE GLUTEN FREE LINE

RICONOSCIBILE A COLPO D'OCCHIO PER UN'ATTENZIONE SPECIALE VERSO I PROPRI CLIENTI

RECOGNISABLE AT A GLANCE FOR A SPECIAL ATTENTION TO YOUR CUSTOMERS



NEW

LINEA BLUE DROP BLUE DROP LINE

UNA MANEGGEVOLEZZA SENZA PARI GRAZIE ALLA PERFETTA UNIONE DI ROBUSTEZZA E LEGGEREZZA

UNPARALLELED PRACTICALITY THANKS TO THE PERFECT COMBINATION OF STRENGTH AND LIGHTNESS

COLLEZIONE PUNTOROSSO

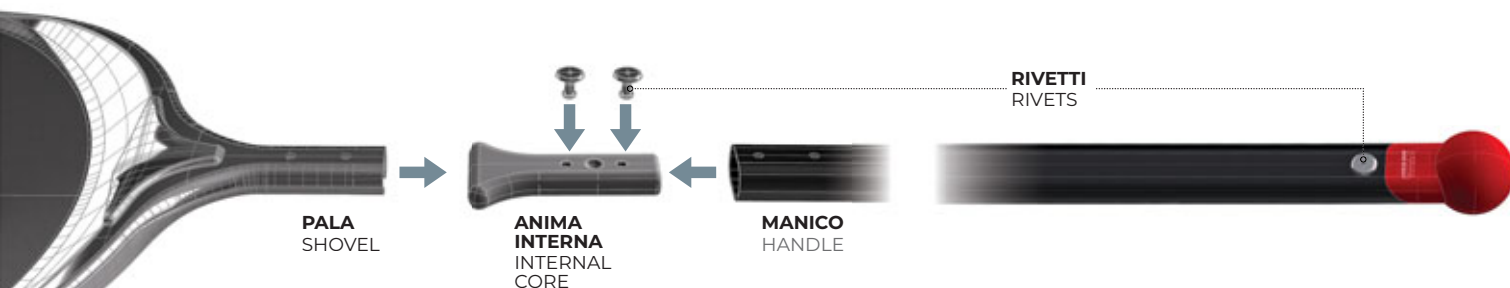

UNA COLLEZIONE PROGETTATA, SVILUPPATA E TESTATA CURANDO OGNI SINGOLO MINIMO DETTAGLIO

- I LATI PALA SMUSSATI RENDONO L'INVITO PIÙ AMPIO E AGEVOLE **1**
- LA SPECIALE NERVATURA POSTERIORE DI RINFORZO GARANTISCE LEGGEREZZA E RESISTENZA AL CALORE
- L'ANIMA INTERNA, INSERITA NELLA PARTE POSTERIORE CAVA DELLA PALA È SOLIDALE CON ESSA E IL MANICO, ENFATIZZA LA ROBUSTEZZA E ASSICURA MASSIMA IGIENE **2**
- IL POMOLO TONDO TERMINALE, RIGIDO INTERNAMENTE E MORBIDO ALL'ESTERNO, (NELLE LINEE DESIGN E GLUTEN FREE), HA FUNZIONE ANTIRUMORE E ANTINFORTUNISTICA
- IL PARTICOLARE DESIGN DELLE FORATURE ALLEGGERISCE PALE E PALETTINI SENZA INTACCARNE LA RIGIDITÀ **3**
- I 3 RIVETTI DI FISSAGGIO (IN LINEA SULLA PALA E A TRIANGOLO SUI PALETTINI) SONO GARANZIA DI SOLIDITÀ **4**

A COLLECTION DESIGNED, DEVELOPED AND TESTED TAKING CARE OF EVERY SINGLE DETAIL

- THE BEVELED PEEL SIDES MAKE THE INVITATION WIDER AND EASIER **1**
- THE SPECIAL REINFORCEMENT RIB ON THE BACK GUARANTEES LIGHTNESS AND HEAT RESISTANCE
- THE INTERNAL CORE IS INSERTED IN THE BACK HOLLOW OF THE PIZZA PEEL AND IS INTEGRAL PART OF IT AND THE HANDLE, EMPHASIZING ROBUSTNESS AND ENSURING MAXIMUM HYGIENE **2**
- TERMINAL ROUND KNOB, RIGID ON THE INSIDE AND SOFT ON THE OUTSIDE, (IN THE DESIGN AND GLUTEN FREE LINES), HAS AN ANTI-NOISE AND ACCIDENT PREVENTION FUNCTION
- THE PARTICULAR DESIGN OF THE DRILLING LIGHTENS PEELS AND TURNING PEELS WITHOUT AFFECTING THEIR RIGIDITY **3**
- THE 3 FASTENING RIVETS (IN LINE ON THE PEELS AND IN A TRIANGLE SHAPE ON THE TURNING PEELS) ARE A GUARANTEE OF SOLIDITY **4**

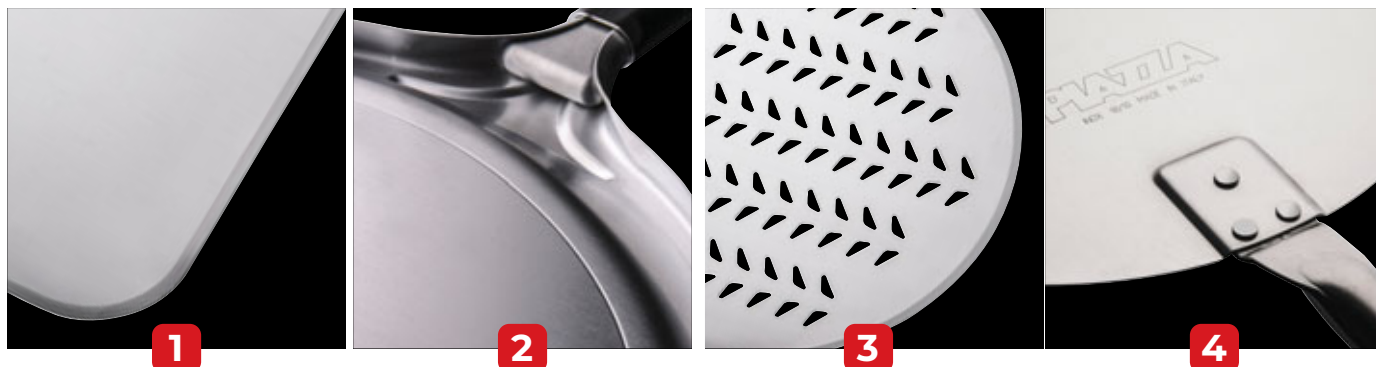

LA PALA OFFRE LA MASSIMA SUPERFICIE DISPONIBILE PER INFORNARE SENZA L'INTRALCIO DELLE NERVATURE. LO SMUSSO SU TRE LATI NE ENFATIZZA PRATICITÀ ED EFFICIENZA

THE DESIGN OF THE PIZZA PEEL OFFERS THE MAXIMUM AVAILABLE SURFACE TO PLACE IN THE OVEN WITHOUT OBSTACLES. THE BEVEL ON THE THREE SIDES EMPHASIZES EASE AND EFFICIENCY



ELASTOMERO MORBIDO ESTERNO
ANTIRUMORE E ANTINFORTUNIO
EXTERNAL SOFT ELASTOMER
SAFE AND NOISE REDUCTION

POLIMERO PLASTICO RIGIDO INTERNO
INNER RIGID PLASTIC POLYMER

LINEA DESIGN DESIGN LINE

LA LINEA DESIGN, SVILUPPATA ASSIEME AI PROFESSIONISTI DEL SETTORE E PROGETTATA FIN NEI MINIMI PARTICOLARI PER OFFRIRE UN'AMPIA GAMMA DI PRODOTTI E GARANTIRE PRESTAZIONI D'ECCELLENZA IN OGNI SITUAZIONE D'UTILIZZO. UNA COMBINAZIONE UNICA DI BELLEZZA ED EFFICIENZA.

THE DESIGN LINE, DEVELOPED WITH PIZZERIA PROFESSIONALS AND DESIGNED DOWN TO THE FINEST DETAILS TO OFFER A WIDE RANGE OF PRODUCTS AND GUARANTEE EXCELLENT PERFORMANCE IN EVERY SITUATION OF USE. A UNIQUE COMBINATION OF BEAUTY AND EFFICIENCY.



Pala pizza rettangolare in alluminio

Rectangular aluminum pizza peel

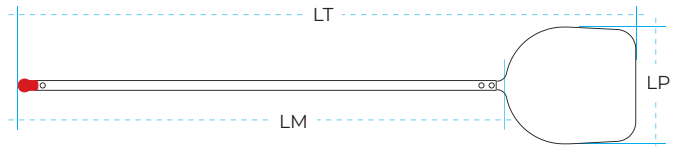

LP 30 cm			LP 33 cm			LP 36 cm			LP 40 cm			LP 45 cm			LP 50 cm		
Cod.	LM	LT	Cod.	LM	LT	Cod.	LM	LT	Cod.	LM	LT	Cod.	LM	LT	Cod.	LM	LT
235002	60	94	235012	60	97	235022	60	100	235032	60	104	235042	60	110	235052	60	115
235004	120	154	235014	120	157	235024	120	160	235034	120	164	235044	120	170	235054	120	175
235006	150	184	235016	150	187	235026	150	190	235036	150	194	235046	150	200	235056	150	205
235008	180	212	235018	180	217	235028	180	220	235038	180	224	235048	180	230	235058	180	235
			235019	200	237	235029	200	240									



Pala pizza rettangolare forata in alluminio

Rectangular perforated aluminum pizza peel

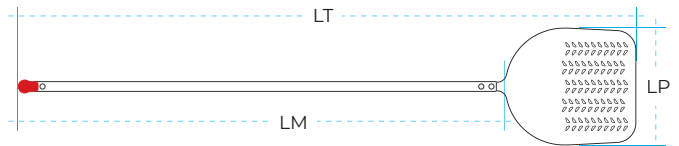

LP 30 cm			LP 33 cm			LP 36 cm			LP 40 cm			LP 45 cm			LP 50 cm		
Cod.	LM	LT	Cod.	LM	LT	Cod.	LM	LT	Cod.	LM	LT	Cod.	LM	LT	Cod.	LM	LT
235102	60	94	235112	60	97	235122	60	100	235132	60	104	235142	60	110	235152	60	115
235104	120	154	235114	120	157	235124	120	160	235134	120	164	235144	120	170	235154	120	175
235106	150	184	235115	130	167	235125	130	170	235135	130	174	235146	150	200	235156	150	205
235108	180	214	235116	150	187	235126	150	190	235136	150	194	235148	180	230	235158	180	235
			235118	180	217	235128	180	220	235138	180	224						
			235119	200	237	235129	200	240									



LIBERI DI SCEGLIERE LA PALA PIÙ ADATTA A VOI
 FREE TO CHOOSE THE MOST SUITABLE PIZZA PEEL FOR YOU

6 DIFFERENTI MISURE
DIFFERENT SIZES

2 TIPOLOGIE (LISCIA E FORATA)
TYPES (PLAIN & PERFORATED)

6 LUNGHEZZE DI MANICO
HANDLE LENGTH



Pala pizza tonda in alluminio

Round aluminum pizza peel

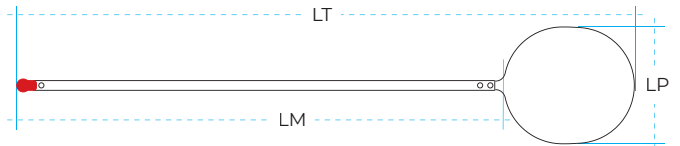

LP 30 cm			LP 33 cm			LP 36 cm			LP 40 cm			LP 45 cm			LP 50 cm		
Cod.	LM	LT	Cod.	LM	LT	Cod.	LM	LT	Cod.	LM	LT	Cod.	LM	LT	Cod.	LM	LT
235202	60	94	235212	60	97	235222	60	100	235232	60	104	235242	60	110	235252	60	115
235204	120	154	235214	120	157	235224	120	160	235234	120	164	235244	120	170	235254	120	175
235206	150	184	235216	150	187	235226	150	190	235236	150	194	235246	150	200	235256	150	205
235208	180	214	235218	180	217	235228	180	220	235238	180	224	235248	180	230	235258	180	235
			235219	200	237	235229	200	240									



Pala pizza tonda forata in alluminio

Round perforated aluminum pizza peel

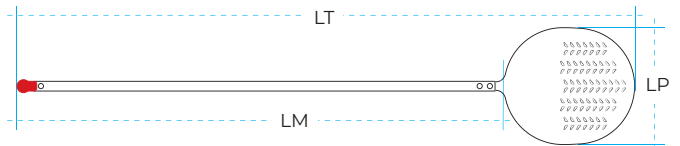

LP 30 cm			LP 33 cm			LP 36 cm			LP 40 cm			LP 45 cm			LP 50 cm		
Cod.	LM	LT	Cod.	LM	LT	Cod.	LM	LT	Cod.	LM	LT	Cod.	LM	LT	Cod.	LM	LT
235302	60	94	235312	60	97	235322	60	100	235332	60	104	235342	60	110	235352	60	115
235304	120	154	235314	120	157	235324	120	160	235334	120	164	235344	120	170	235354	120	175
235306	150	184	235316	150	187	235326	150	190	235336	150	194	235346	150	200	235356	150	205
235308	180	214	235318	180	217	235328	180	220	235338	180	224	235348	180	230	235358	180	235
			235319	200	237	235329	200	240									



PIZZERIA - LINEA DESIGN PIZZERIA - DESIGN LINE



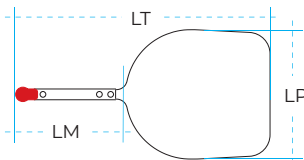

**Pala pizza rettangolare in alluminio
Manico corto**

Rectangular aluminum pizza peel - Short handle

LP 30 cm			LP 33 cm			LP 36 cm			LP 40 cm			LP 45 cm			LP 50 cm		
Cod.	LM	LT	Cod.	LM	LT	Cod.	LM	LT	Cod.	LM	LT	Cod.	LM	LT	Cod.	LM	LT
235000	30	64	235010	30	67	235020	30	70	235030	30	74	235040	30	80	235050	30	85

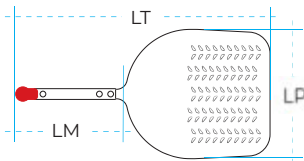

**Pala pizza rettangolare
forata in alluminio
Manico corto**

Rectangular perfor. aluminum pizza peel - Short handle

LP 30 cm			LP 33 cm			LP 36 cm			LP 40 cm			LP 45 cm			LP 50 cm		
Cod.	LM	LT	Cod.	LM	LT	Cod.	LM	LT	Cod.	LM	LT	Cod.	LM	LT	Cod.	LM	LT
235100	30	64	235110	30	67	235120	30	70	235130	30	74	235140	30	80	235150	30	85

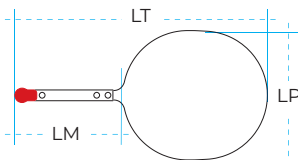

**Pala pizza tonda in alluminio
Manico corto**

Round aluminum pizza peel - Short handle

LP 30 cm			LP 33 cm			LP 36 cm			LP 40 cm			LP 45 cm			LP 50 cm		
Cod.	LM	LT	Cod.	LM	LT	Cod.	LM	LT	Cod.	LM	LT	Cod.	LM	LT	Cod.	LM	LT
235200	30	64	235210	30	67	235220	30	70	235230	30	74	235240	30	80	235250	30	85

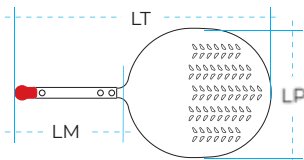

**Pala pizza tonda
forata in alluminio
Manico corto**

Round perfor. aluminum pizza peel - Short handle

LP 30 cm			LP 33 cm			LP 36 cm			LP 40 cm			LP 45 cm			LP 50 cm		
Cod.	LM	LT	Cod.	LM	LT	Cod.	LM	LT	Cod.	LM	LT	Cod.	LM	LT	Cod.	LM	LT
235300	30	64	235310	30	67	235320	30	70	235330	30	74	235340	30	80	235350	30	85



I PALETTINI PIZZA, PAROLE D'ORDINE: EFFICIENZA E PRATICITÀ
 PIZZA TURNING PEELS, PASSWORDS: EFFICIENCY AND PRACTICALITY

5 LUNGHEZZE DI MANICO, 4 DIFFERENTI MISURE E 2 TIPOLOGIE DI PALETTINO (LISCIO E FORATO)
 5 HANDLE LENGTH, 4 DIFFERENT SIZES AND 2 TYPES OF PIZZA TURNING PEELS (PLAIN AND PERFORATED)

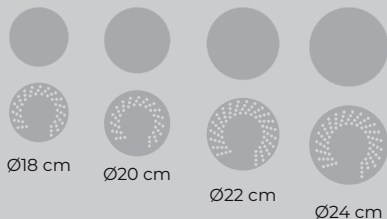

L'ERGONOMICA IMPUGNATURA POSTERIORE È REALIZZATA IN POLIMERO PLASTICO AD ALTA DENSITÀ, CONIUGA LA RESISTENZA AGLI URTI CON L'ISOLAMENTO DELLE MANI DAL CALORE. LA PARTE FISSA POSTERIORE È FISSATA AL MANICO CON UN RIVETTO IN ACCIAIO. LA PARTE MOBILE SCORRE SUL MANICO DAL FERMO ALLA PARTE FISSA, NELLA QUALE, A RIPOSO, SI INCASTRA E SI BLOCCA
 THE ERGONOMIC PIZZA TURNING PEEL GRIP IS MADE OF HIGH-DENSITY PLASTIC POLYMER, IT COMBINES IMPACT RESISTANCE WITH PERFECT INSULATION OF THE HANDS FROM HEAT. THE REAR FIXED PART IS FIXED TO THE HANDLE WITH A STEEL RIVET. THE MOBILE PART SLIDES ON THE HANDLE FROM THE STOP TO THE FIXED PART, WHERE, AT REST, IT FITS AND LOCKS

LO SPECIALE DESIGN DEI FORI, PERIMETRALE E A RAGGIERA, EVITA LA FORATURA NELLA PARTE CENTRALE DEL PALETTINO, GARANTENDO UNA PERFETTA RIGIDITÀ
 THE SPECIAL DESIGN OF THE HOLES, PERIMETER AND RADIAL, AVOIDS DRILLING IN THE CENTRAL PART OF THE PIZZA TURNING PEEL, GUARANTEEING PERFECT RIGIDITY WITH A REDUCED THICKNESS

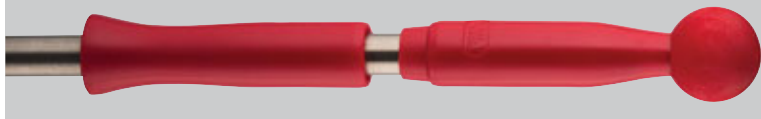
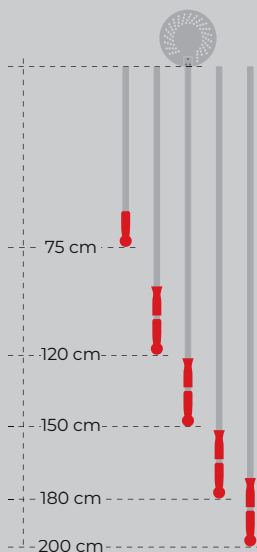

Palettino in inox

Stainless steel pizza turning peel

LP Ø18 cm			LP Ø20 cm			LP Ø22 cm			LP Ø24 cm		
Cod.	LM	LT	Cod.	LM	LT	Cod.	LM	LT	Cod.	LM	LT
236002*	75	93	236012*	75	95	236022*	75	97	236032*	75	99
236004	120	138	236014	120	140	236024	120	142	236034	120	144
236006	150	168	236016	150	170	236026	150	172	236036	150	174
236008	180	198	236018	180	200	236028	180	202	236038	180	204
236009	200	218	236019	200	220	236029	200	222	236039	200	224

* NEI MODELLI CON MANICO DA 75 CM L'IMPUGNATURA HA SOLO LA PARTE FISSA POSTERIORE
 IN MODELS WITH A 75 CM HANDLE, THE GRIP ONLY HAS THE REAR FIXED PART

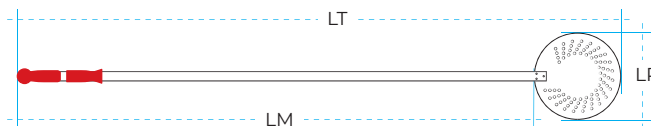

Palettino in inox forato

Perforated stainless steel pizza turning peel

LP Ø18 cm			LP Ø20 cm			LP Ø22 cm			LP Ø24 cm		
Cod.	LM	LT	Cod.	LM	LT	Cod.	LM	LT	Cod.	LM	LT
236102*	75	93	236112*	75	95	236122*	75	97	236132*	75	99
236104	120	138	236114	120	140	236124	120	142	236134	120	144
236106	150	168	236116	150	170	236126	150	172	236136	150	174
236108	180	198	236118	180	200	236128	180	202	236138	180	204
236109	200	218	236119	200	220	236129	200	222	236139	200	224

* NEI MODELLI CON MANICO DA 75 CM L'IMPUGNATURA HA SOLO LA PARTE FISSA POSTERIORE
 IN MODELS WITH A 75 CM HANDLE, THE GRIP ONLY HAS THE REAR FIXED PART







**Pala pizza
"Alla Romana" in alluminio**

Aluminum 'Roman style' pizza peel	Cod.	LP cm	LM cm	LT cm
	235400	23x40	30	77
	235402	23x40	60	107
	235404	23x40	120	167

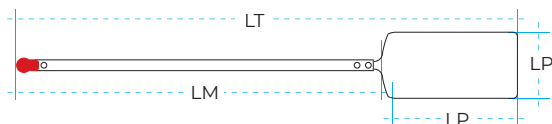

**Pala pizza forata
"Alla Romana" in alluminio**

Perforated aluminum 'Roman style' pizza peel	Cod.	LP cm	LM cm	LT cm
	235500	23x40	30	77
	235502	23x40	60	107
	235504	23x40	120	167

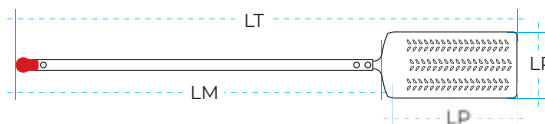

**Asse per pizza
"Alla Romana" in alluminio**

Aluminum 'Roman style' pizza board	Cod.	LP cm
	235802	25x50

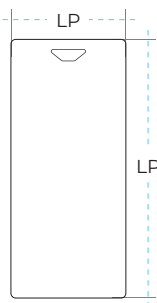

**Asse forato per pizza
"Alla Romana" in alluminio**

Perforated aluminum 'Roman style' pizza board	Cod.	LP cm
	235842	25x50



**Asse per pizza
"A Metro" in alluminio**

Aluminum 'Pizza by the Metre' board	Cod.	LP cm
	235812	30x70
	235814	30x90
	235822	40x70
	235824	40x90
	235826	40x110

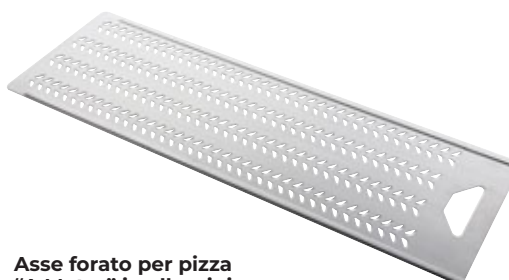

**Asse forato per pizza
"A Metro" in alluminio**

Perforated aluminum 'Pizza by the Metre' board	Cod.	LP cm
	235852	30x70
	235854	30x90
	235862	40x70
	235864	40x90
	235866	40x110



SPESSORE ASSI 2 mm
BOARDS THICKNESS

LA PULIZIA FORNO: UNA QUESTIONE DI QUALITÀ

OVEN CLEANING: A MATTER OF QUALITY

La pulizia del forno è fondamentale per garantire qualità, sicurezza e continuità del lavoro. Un forno ben mantenuto assicura una cottura uniforme delle pizze, evitando residui bruciati che potrebbero alterarne il sapore. Inoltre, rimuovere regolarmente cenere, grassi e incrostazioni riduce il rischio di fumo e cattivi odori, preservando un ambiente di lavoro più salubre. Una corretta manutenzione inoltre previene anche guasti e prolunga la vita dell'attrezzatura.

Cleaning the oven is essential to ensure quality, safety, and continuity of work. A well-maintained oven guarantees even cooking of the pizzas, preventing burnt residues that could affect their flavor. Additionally, regularly removing ash, grease, and buildup reduces the risk of smoke and unpleasant odors, helping maintain a healthier work environment. Proper maintenance also prevents malfunctions and extends the lifespan of the equipment.

SPAZZOLE SETOLE OTTONE

BRUSHES BRASS BRISTLE

20x6 H 7 cm

27x6,5 H 7 cm

Ø17x14 H 7 cm

SPAZZOLE SETOLE NATURALI

BRUSHES NATURAL BRISTLE

20x6 H 7 cm

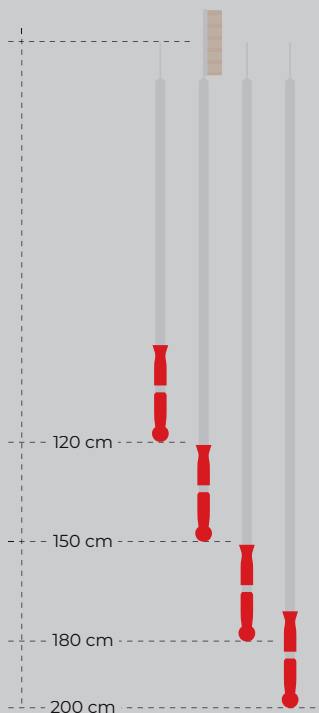

MANICO IN ACCIAIO INOX TONDO PERFETTAMENTE BILANCIATO CON DIAMETRO 18 MM E SPESSORE DI 1 MM
ROUND HANDLE IN STAINLESS STEEL PERFECTLY BALANCED WITH 18 MM DIAMETER AND THICKNESS OF 1 MM

L'IMPUGNATURA REALIZZATA CON DUE MATERIALI: RIGIDO ALL'INTERNO E MORBIDO ALL'ESTERNO, CARATTERIZZA, FUNZIONALMENTE ED ESTETICAMENTE, TUTTA LA LINEA PIZZERIA, MENTRE IL POMOLO TERMINALE HA UNA FUNZIONE ANTIRUMORE ED IL SUO DESIGN ATTUTISCE GLI URTI IN CASO DI CONTATTO

THE HANDLE MADE OF TWO MATERIALS: RIGID INSIDE AND SOFT ON THE OUTSIDE, IT CHARACTERIZES, FUNCTIONALLY AND AESTHETICALLY, THE ENTIRE PIZZERIA LINE, WHILE THE TERMINAL KNOB HAS A FUNCTION ANTI-NOISE AND ITS DESIGN ABSORBS SHOCKS IN CASE OF CONTACT.

4 MISURE DI MANICI, 4 MISURE DI SPAZZOLA, 2 TIPOLOGIE

4 HANDLE SIZES,
4 BRUSH SIZES,
2 TYPES



Spazzolone forno orientabile rettangolare - Setole ottone

Rectangular rotatable oven brush with brass bristle

LS 20x6 H 7 cm

LS 27x6,5 H 7 cm

Cod.	LM	LT	Cod.	LM	LT
237004	120	133	237104	120	137
237006	150	163	237106	150	167
237008	180	193	237108	180	197
237009	200	213	237109	200	217

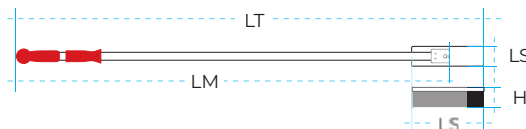

Spazzolone forno orientabile rettangolare - Setole naturali

Rectangular rotatable oven brush with natural bristle

LS 20x6 H 7 cm

Cod.	LM	LT
237014	120	133
237016	150	163
237018	180	193
237019	200	213

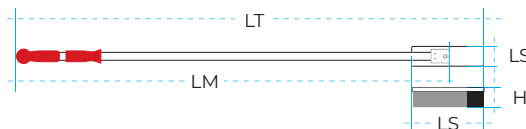

Spazzolone forno orientabile tondo - Setole ottone

Round rotatable oven brush with brass bristle

LS Ø17x14 H 7 cm

Cod.	LM	LT
237504	120	131
237506	150	161
237508	180	191
237509	200	211

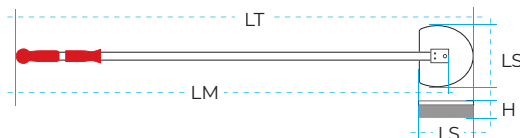



Spazzola forno - Setole ottone

Oven brush Brass bristle	Cod.	L x W cm	H cm
	237900	20 x 6	7
	237905	27 x 6,5	7



Spazzola forno - Setole naturali

Oven brush Natural bristle	Cod.	L x W cm	H cm
	237901	20 x 6	7



**Spazzola forno tonda
Setole ottone**

Round oven brush Brass bristle	Cod.	L x W cm	H cm
	237920	Ø17 x 14	7



IL SISTEMA DI AGGANCIAMENTO DELLA SPAZZOLA AL MANICO NE CONSENTE LA ROTAZIONE A 360°
 THE HOOKING SYSTEM OF BRUSH AND HANDLE ALLOWS A 360° ROTATION



**Spazzolone forno rettangolare
"Cambio rapido" - Setole ottone**

Rectangular brass bristle 'Fast change' oven brush	Cod.	LS cm	LM cm	LT cm
	237206	16,5x5,5 H 7	150	167



**Spazzolone forno rettangolare
"Cambio rapido" - Setole naturali**

Rectangular natur. bristle 'Fast change' oven brush	Cod.	LS cm	LM cm	LT cm
	237216	16,5x5,5 H 7	150	167

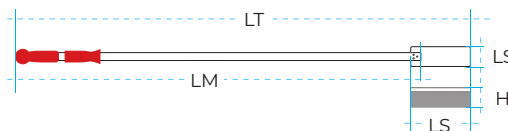

Spazzola forno "Cambio Rapido"

'Fast Change' oven brush	Cod.	Mat.
	231000	ottone/brass
	231100	setole natur./natur. bristle



Pala braci

Charcoal shovel	Cod.	LP cm	LM cm	LT cm
	239006	21,5x17,5	150	171

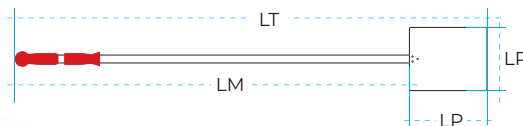

Tirabracci in acciaio

Oven rake	Cod.	LP cm	LM cm	LT cm
	239106	19	150	169

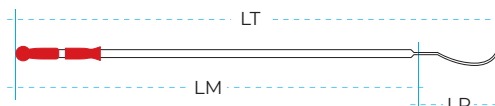

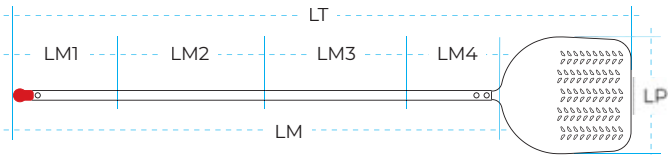

Pala pizza smontabile rettangolare forata in alluminio

Removable rectangular perforated aluminum pizza peel

LP 33 cm

Cod.	LM1	LM2	LM3	LM4	LM	LT
235116S	27	50	50	23	150	187



LE PALE PIZZA SMONTABILI
THE REMOVABLE PIZZA PEELS

- COMODE DA TRASPORTARE CON LA BORSA DA VIAGGIO
- LUNGHEZZA DEL MANICO REGOLABILE A PIACERE
- MONTAGGIO E SMONTAGGIO FACILE E RAPIDO (KIT DI MONTAGGIO INCLUSO)
- MONTAGGIO DI PALETTINO E SPAZZOLONE ANCHE SENZA ATTREZZI (BASTA UNA MONETA)
- EASY TO CARRY WITH THE TRAVEL BAG
- ADJUSTABLE HANDLE LENGTH
- QUICK AND EASY ASSEMBLY AND DISASSEMBLY (ASSEMBLY KIT INCLUDED)
- ASSEMBLY OF THE TURNING PEEL AND OVEN BRUSH EVEN WITHOUT TOOLS (ALL YOU NEED IS A COIN)

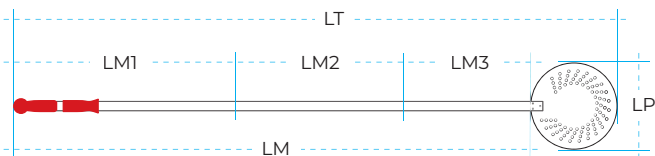
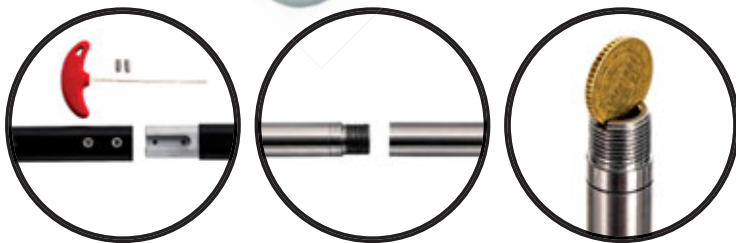

Palettino in inox smontabile forato

Removable perforated stainless steel pizza turning peel

LP Ø20 cm

Cod.	LM1	LM2	LM3	LM	LT
236116S	60	50	40	150	170



Spazzolone forno orientabile smontabile - Setole ottone

Removable rotatable oven brush with brass bristle

LS 20x6 H 7 cm

Cod.	LM1	LM2	LM3	LM	LT
237006S	60	50	46	156	163



NEW



Borsa da viaggio pizzaiolo

Pizza Chef travel bag	Cod.	L x W cm	H cm
	239910	75 x 46	6

NEW



Borsa da viaggio pizzaiolo - Kit 1

Pizza Chef travel bag Kit 1	Cod.	L x W cm	H cm
	239911	75 x 46	6

NEW



Borsa da viaggio pizzaiolo - Kit 2

Pizza Chef travel bag Kit 2	Cod.	L x W cm	H cm
	239912	75 x 46	6

IL KIT 1 COMPRENDE I SEGUENTI ARTICOLI
THE KIT 1 INCLUDES THE FOLLOWING ITEMS

- 240210 SPATOLA TRIANGOLARE 10x12 CM TRIANGLE SPATULA 10x12 CM
- 241110 ROTELLA TAGLIAPIZZA Ø10 CM PIZZA WHEEL CUTTER Ø10 CM
- 240601 RASCHIA 12x9,5 CM SCRAPER 12x9,5 CM
- 15790900 MESTOLO PIZZA NYLON & FIBERGLASS PIZZA LADLE
- 014500 MOLLA DI PRECISIONE 30 CM PRECISION TONGS 30 CM
- 239910 BORSA DA VIAGGIO PIZZAIOLO PIZZA CHEF TRAVEL BAG
- 235116S PALA PIZZA SMONTABILE REMOVABLE PIZZA PEEL
- 236116S PALETTINO PIZZA SMONTABILE REMOVABLE TURNING PEEL

IL KIT 2 COMPRENDE I SEGUENTI ARTICOLI
THE KIT 2 INCLUDES THE FOLLOWING ITEMS

- 240210 SPATOLA TRIANGOLARE 10x12 CM TRIANGLE SPATULA 10x12 CM
- 241110 ROTELLA TAGLIAPIZZA Ø10 CM PIZZA WHEEL CUTTER Ø10 CM
- 240601 RASCHIA 12x9,5 CM SCRAPER 12x9,5 CM
- 15790900 MESTOLO PIZZA NYLON & FIBERGLASS PIZZA LADLE
- 014500 MOLLA DI PRECISIONE 30 CM PRECISION TONGS 30 CM
- 239910 BORSA DA VIAGGIO PIZZAIOLO PIZZA CHEF TRAVEL BAG
- 235116S PALA PIZZA SMONTABILE REMOVABLE PIZZA PEEL
- 236116S PALETTINO PIZZA SMONTABILE REMOVABLE TURNING PEEL
- 237006S SPAZZOLONE ORIENTABILE SMONTABILE REMOVABLE ROTABLE OVEN BRUSH

COMPONI IL TUO SET PIZZERIA CREATO SU MISURA IN BASE ALLE TUE ESIGENZE
CREATE YOUR OWN PIZZERIA SET TAILORED TO YOUR NEEDS



SCEGLI GLI ARTICOLI CHE TI SERVONO ALL'INTERNO DELLA SEZIONE PIZZERIA
CHOOSE THE ITEMS YOU NEED IN THE PIZZERIA SECTION



PRENDI NOTA DEL CODICE DEL PRODOTTO
NOTE THE ITEM CODE



INVIACI UNA MAIL CON LA TUA RICHIESTA
SEND US AN EMAIL WITH YOUR REQUEST
piazza@piazza.it



VERRAI RICONTATTATO DA NOI QUANTO PRIMA
WE WILL CONTACT YOU AS SOON AS POSSIBLE

LINEA TRADIZIONE TRADITION LINE

**GRAZIE AL DESIGN DI MICHELE CAPUANI
LA NUOVA IMPUGNATURA IN LEGNO
RINNOVA E AGGIORNA I TRADIZIONALI
PRODOTTI PIZZERIA PIAZZA RENDENDOLI
PIÙ EFFICIENTI, PIÙ PRATICI E ANCORA PIÙ BELLI**

THANKS TO THE DESIGN BY MICHELE CAPUANI
THE NEW WOODEN HANDLE RENEWS
AND UPDATES PIAZZA PIZZERIA TRADITIONAL
PRODUCTS MAKING THEM MORE EFFICIENT,
MORE PRACTICAL AND EVEN MORE BEAUTIFUL



**Pala pizza rettangolare
in alluminio**

Rectangular
aluminum pizza peel

LP 33 cm

Cod.	LM	LT
230433	150	187

LP 36 cm

Cod.	LM	LT
230436	150	190

LP 40 cm

Cod.	LM	LT
230440	150	194

LP 45 cm

Cod.	LM	LT
230445	150	200

LP 50 cm

Cod.	LM	LT
230450	150	205

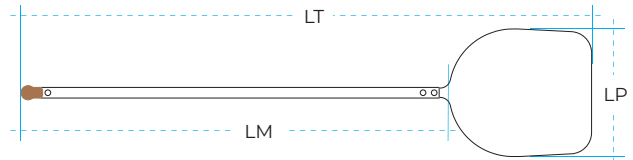

Palettino pizza

Pizza turning peel

LP Ø18 cm

Cod.	LM	LT
230018	150	168

LP Ø20 cm

Cod.	LM	LT
230020	150	170

LP Ø22 cm

Cod.	LM	LT
230022	150	172

LP Ø24 cm

Cod.	LM	LT
2300024	150	174

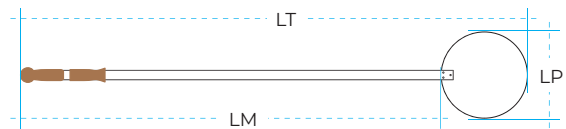

Palettino pizza forato

Perforated pizza turning peel

LP Ø18 cm

Cod.	LM	LT
232018	150	168

LP Ø20 cm

Cod.	LM	LT
232020	150	170

LP Ø22 cm

Cod.	LM	LT
232022	150	172

LP Ø24 cm

Cod.	LM	LT
2320024	150	174

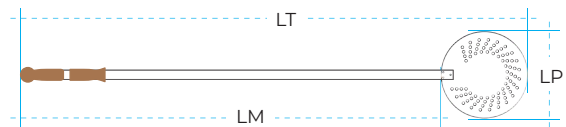



IL FISSAGGIO PALA-MANICO
THE SHOVEL-HANDLE FIXING



LO SMUSSO DELLA PALA
THE SHOVEL'S BEVEL



Pala braci

Charcoal shovel : Cod. LP cm LM cm LT cm
230600 21,5x17,5 150 171

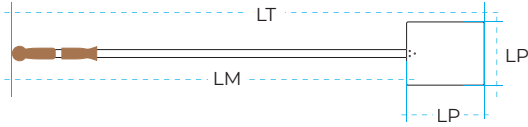

Tirabraci in acciaio

Oven rake : Cod. LP cm LM cm LT cm
230700 19 150 169

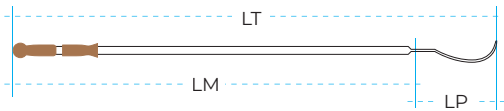

Spazzolone forno rettangolare "Cambio rapido" - Setole ottone

Rectangular brass bristle 'Fast change' oven brush : Cod. LS cm LM cm LT cm
231200 16,5x5,5 H 7 150 167



Spazzolone forno rettangolare "Cambio rapido" - Setole naturali

Rectangular nat. bristle 'Fast change' oven brush : Cod. LS cm LM cm LT cm
231300 16,5x5,5 H 7 150 167

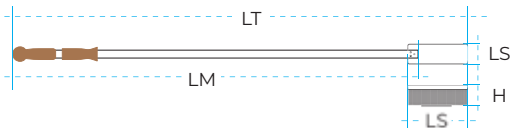

Pala pizza rettangolare in legno

Rectangular wooden pizza peel

LP 33 cm

LP 36 cm

LP 40 cm

Cod. LM LT : Cod. LM LT : Cod. LM LT
238016 153 187 **238026** 153 190 **238036** 153 194

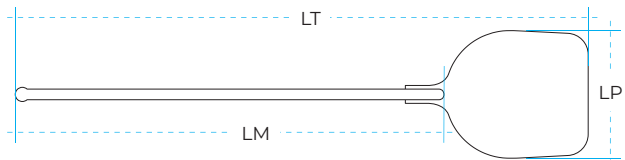

- REALIZZATA IN LEGNO DI FAGGIO MASSICCIO EVAPORATO, LA CUI PARTICOLARE DUREZZA GARANTISCE ROBUSTEZZA E DURATA NEL TEMPO
- RINFORZATA CON BARRE DI ACCIAIO INOX INTERNE.
- SPESSORE: 12 MM.
- IL TRATTAMENTO CON OLIO ENOLOGICO, CERTIFICATO PER USO ALIMENTARE, RIDUCE L'USURA E AL CONTEMPO FAVORISCE LO SCORRIMENTO DELL'IMPASTO
- ANCH'ESSA SMUSSATA SU TRE LATI, PER FAVORIRE, SIA IL TRASCINAMENTO DELL'IMPASTO SULLA PALA CHE IL SOLLEVAMENTO DELLA PIZZA

- MADE OF EVAPORATED SOLID BEECH WOOD, WHOSE PARTICULAR HARDNESS GUARANTEES STURDINESS AND DURABILITY

- REINFORCED WITH INTERNAL STAINLESS STEEL BARS

- THICKNESS: 12 MM.

- THE TREATMENT WITH OENOLOGICAL OIL, CERTIFIED FOR FOOD USE, REDUCES WEAR AND AT THE SAME TIME FAVORS THE FLOW OF THE DOUGH

- ALSO BEVELED ON THREE SIDES, IN ORDER TO FACILITATE BOTH THE DRAGGING OF THE DOUGH ON THE PIZZA PEEL AND THE LIFTING OF THE PIZZA

MANICO IN LEGNO

- OVALE A FACCE PARALLELE
- SPESSORE: 15 MM.

WOODEN HANDLE

- OVAL WITH PARALLEL FACES
- THICKNESS: 15 MM.

FISSAGGIO DEL MANICO

- CON VITI A SCOMPARSA A GARANTIRE LA MASSIMA SOLIDITÀ DELL'ASSEMBLAGGIO DI PALA E MANICO

FIXING OF THE HANDLE

- WITH CONCEALED SCREWS TO ENSURE MAXIMUM SOLIDITY OF THE ASSEMBLY OF SHOVEL AND PEEL



Pala pizza legno betulla

Birch wooden pizza peel : Cod. L x W cm
248100 29,5 x 42



LINEA GLUTEN FREE GLUTEN FREE LINE

IL POMOLO TERMINALE E LE IMPUGNATURE DI COLORE VERDE CONTRADDISTINGUONO QUESTA LINEA, CHE VANTA LE STESSE CARATTERISTICHE D'ECCELLENZA DELLE ALTRE, RENDENDOLA COSÌ IMMEDIATAMENTE RICONOSCIBILE

THE GREEN KNOB AND HANDLES DISTINCTIVELY DISTINGUISH THIS LINE, WHICH BOASTS THE SAME EXCELLENT FEATURES AS THE OTHERS, MAKING IT IMMEDIATELY RECOGNIZABLE



Pala pizza rettangolare "Gluten Free" in alluminio

Rectangular aluminum pizza peel for 'Gluten Free' products

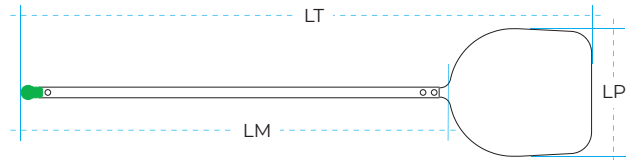

LP 33 cm

Cod.	LM	LT
235616	150	187

LP 36 cm

Cod.	LM	LT
235626	150	190



Palettino forato "Gluten Free" in inox

Perforated stainless steel pizza turning peel for 'Gluten Free' products

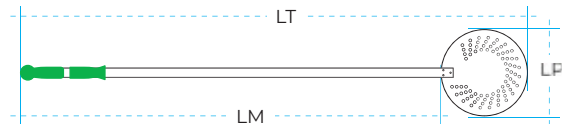

LP Ø20 cm

Cod.	LM	LT
236316	150	170

LP Ø22 cm

Cod.	LM	LT
236326	150	172



Spazzolone forno "Gluten Free" orientabile rettangolare - Setole ottone

Rectangular oven brush with rotatable brass bristle for 'Gluten Free' products



LS 20x6 H 7 cm

Cod.	LM	LT
237056	150	163



1. IMBALLO INDIVIDUALE

Ogni prodotto viene consegnato imballato singolarmente in una scatola in cartone polionda.

2. FACILITÀ DI STOCCAGGIO

Un adesivo esterno con le specifiche del prodotto ne consente l'immediata identificazione all'interno del vostro magazzino.

1. INDIVIDUAL PACKAGING

Each product is delivered individually packed in a corrugated cardboard box.

2. EASE OF STORAGE

An external sticker with product specifications allows immediate identification within your warehouse.



3. MASSIMA PROTEZIONE

All'interno dell'imballo in cartone un sacchetto in plastica o una scatola (per le spazzole), offrono un'ulteriore protezione alle parti più soggette a urti e graffi.

4. INFORMAZIONI CHIARE

Ogni prodotto è accompagnato da un foglio "parlante" che ne riporta le caratteristiche principali: tipologia, materiale, dimensioni, ecc.

3. MAXIMUM PROTECTION

Inside the cardboard packaging, a plastic bag or a box (for the brushes), offer further protection to the most subject parts to bumps and scratches.

4. CLEAR INFORMATION

Each product is accompanied by a "talking" sheet which shows its main characteristics: type, material, dimensions, etc.



NEW

LINEA BLUE DROP

BLUE DROP LINE

BLUE DROP È LA NOSTRA NUOVA LINEA PIZZERIA. MASSIMA LEGGEREZZA E GRANDE MANEGGEVOLEZZA D'USO SONO LE CARATTERISTICHE PRINCIPALI DELLE NOSTRE PALE IN ALLUMINIO SENZA ANIMA, DEI PALOTTINI IN INOX E DEGLI SPAZZOLONI CON MANICO IN ACCIAIO E SPAZZOLA ORIENTABILE.

BLUE DROP IS OUR NEW PIZZERIA LINE. MAXIMUM LIGHTNESS AND OUTSTANDING HANDLING ARE THE MAIN FEATURES OF OUR CORELESS ALUMINUM PEELS, OUR STAINLESS STEEL TURNING PEELS AND OUR OVEN BRUSHES WITH STEEL HANDLE AND ADJUSTABLE BRUSH HEAD.



- **LEGGERE MA ROBUSTE**
- **FACILI DA APPENDERE**
- LIGHT BUT STURDY
- EASY HANGING



NEW

Pala pizza rettangolare in alluminio

Rectangular aluminum pizza peel

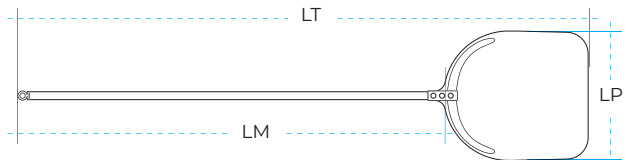

LP 33 cm

Cod.	LM	LT
232513	90	126
232514	120	156
232516	150	186

LP 36 cm

Cod.	LM	LT
232523	90	130
232524	120	160
232526	150	190



NEW

Pala pizza rettangolare forata in alluminio

Rectangular perforated aluminum pizza peel

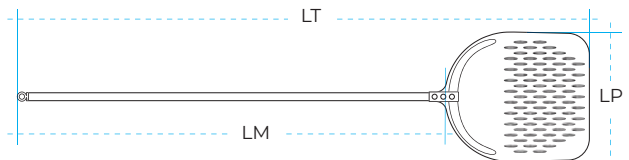

LP 33 cm

Cod.	LM	LT
232613	90	126
232614	120	156
232616	150	186

LP 36 cm

Cod.	LM	LT
232623	90	130
232624	120	160
232626	150	190



NEW

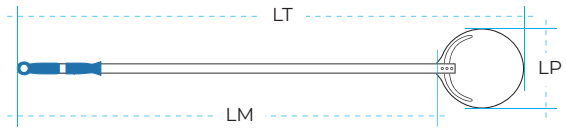

Palettino in inox

Stainless steel pizza turning peel

LP Ø18 cm

Cod.	LM	LT
233303	90	109
233304	120	139
233306	150	169

LP Ø20 cm

Cod.	LM	LT
233323	90	113
233324	120	14
233326	150	173



NEW

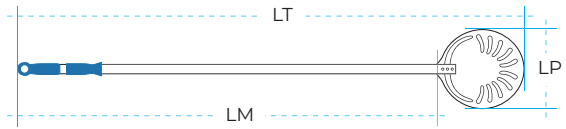

Palettino in inox forato

Perforated stainless steel pizza turning peel

LP Ø18 cm

Cod.	LM	LT
233403	90	109
233404	120	139
233406	150	169

LP Ø20 cm

Cod.	LM	LT
233423	90	113
233424	120	14
233426	150	173



NEW

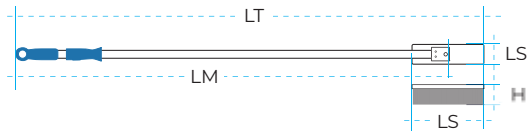

Spazzolone forno orientabile rettangolare - Setole ottone

Rectangular oven brush with rotatable brass bristle

LS 20x6 H 7 cm

Cod.	LM	LT
233703	90	102
233704	120	132
233706	150	162



NEW

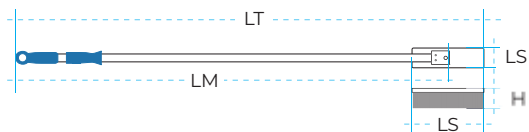

Spazzolone forno orientabile rettangolare - Setole naturali

Rectangular oven brush with rotatable natural bristle

LS 20x6 H 7 cm

Cod.	LM	LT
233713	90	102
233714	120	132
233716	150	162





Appendipala inox da parete - 1 posto

St. steel wall mounted
1 place peel rack

Cod.	L x W cm	H cm
239501	19 x 4	6



Appendipala inox da parete - 3 posti

St. steel wall mounted
3 places peel rack

Cod.	L x W cm	H cm
239503	30 x 5	5



APPENDIPALA 1 POSTO
1 PLACE PEEL RACK



APPENDIPALE 3 POSTI
3 PLACES PEEL RACK



NEW



Appendipala inox da parete - 6 posti

St. steel wall mounted
6 places peel rack

Cod.	L x W cm	H cm
239506	30 x 5	5

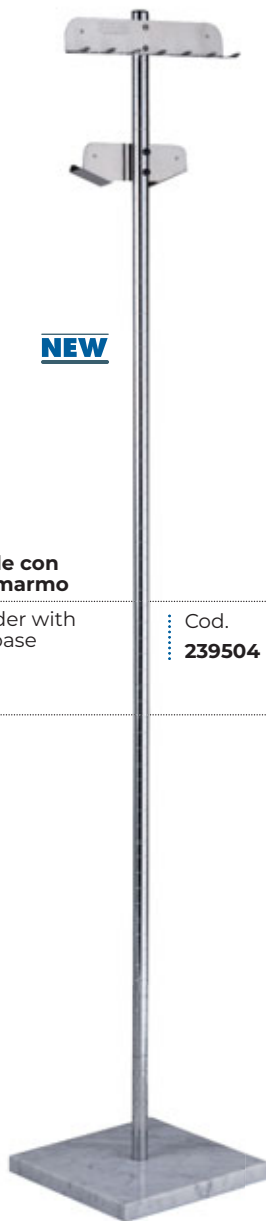

NEW

Portapale con base in marmo

Peel holder with
marble base

Cod.	L x W cm	H cm
239504	29,5 x 29 x 5	182



PER QUESTO PORTAPALE È DISPONIBILE, SU RICHIESTA, IL CARTELLO AGGANCIABILE MOSTRATO QUI SOTTO
FOR THIS PEEL HOLDER THE ATTACHABLE SIGN, SHOWN HERE BELOW, IS AVAILABLE UPON REQUEST



cm 100

cm 18





Spazzola e raschietto 2 usi con setole in inox

2 in 1 brush and scraper with st. steel bristle

Cod.	L cm
231250	23



Alare

Fire dog

Cod.	H cm
231400	41



Contentore palline per pizza in plastica con coperchio

Plastic box for dough stackable with lid

Cod.	L x W cm	H cm
245211	60 x 40	10



NEW

Contentore palline per pizza in plastica

Plastic box for dough stackable

Cod.	L x W cm	H cm	Col.
245310	40 x 30	10	○
2453101	40 x 30	10	●
2453104	40 x 30	10	●



Contentore palline per pizza in plastica

Plastic box for dough stackable

Cod.	L x W cm	H cm
245207	60 x 40	7
245210	60 x 40	10



Coperchio contenitore palline per pizza in plastica

Plastic cover

Cod.	L x W cm
245400	60 x 40
245401	40 x 30

NEW



Oliera in rame e ottone

Copper and brass oil cruet

Cod.	lt
246005	0,5
246010	1
246015	1,5



Cucchiaione

Basting spoon

Cod.
431900





Placca alluminio microforata

Micro-perforated aluminium plate	Cod.	L x W cm	H cm
	251030	30 x 40	1
	251032	32 x 53	1
	251060	40 x 60	1



Teglia cottura ferro blu diamantata con X di rinforzo

Blue iron baking tray with reinforcement X	Cod.	L x W cm	H cm
	252063	40 x 60	2



Teglia cottura ferro blu con pareti dritte

Blue iron baking tray with straight edges	Cod.	L x W cm	H cm
	252061	40 x 60	2



Teglia cottura alluminio forata

Perforated aluminium baking tray	Cod.	L x W cm	H cm
	252161	40 x 60	2



Teglia cottura alluminata con pareti dritte

Aluminized baking tray with straight edges	Cod.	L x W cm	H cm
	252061	40 x 60	2



Teglia cottura tonda ferro blu

Round blue iron baking tray	Cod.	Ø cm	H cm
	252514	14	2,5
	252516	16	2,5
	252518	18	2,5
	252520	20	2,5
	252522	22	2,5
	252524	24	2,5
	252526	26	2,5
	252528	28	2,5
	252530	30	2,5
	252532	32	2,5
	252536	36	2,5
	252540	40	2,5
	252545	45	2,5
	252550	50	2,5



Teglia cottura alluminata antiaderente con pareti dritte

Aluminized baking tray with non stick coating and straight edges	Cod.	L x W cm	H cm
	252062	40 x 60	2





Teglia cottura alluminio

Round baking tray	Cod.	Ø cm	H cm
	252521	20	2,5
	252525	24	2,5
	252529	28	2,5
	252533	32	2,5



Teglia cottura alluminio

Aluminium baking tray	Cod.	L x W cm	H cm
	253135	35 x 35	3
	253140	30 x 40	3
	253150	35 x 50	3
	253160	40 x 60	3



Teglia cottura ferro blu

Blue iron baking tray	Cod.	L x W cm	H cm
	253030	23 x 30	3
	253035	28 x 35	3
	253040	30 x 40	3
	253045	35 x 45	3
	253050	35 x 50	3
	253060	40 x 60	3
	253065	45 x 65	3



Tortiera alta ferro blu

Blue iron high-sided cake pan	Cod.	Ø cm	H cm
	254014	14	4
	254016	16	4
	254018	18	4
	254020	20	4
	254022	22	4
	254024	24	4
	254026	26	4
	254028	28	4
	254030	30	4
	254032	32	4
	254036	36	4
	254040	40	4
	254045	45	4
	254050	50	4
	254060	60	4



Teglia cottura ferro blu con pareti svasate

Blue iron baking tray with flared corners	Cod.	L x W cm	H cm
	253041	30 x 40	3
	253061	40 x 60	3







Spatola angolare

Design by Michele Capuani

Angular spatula

Cod.	L cm
240010	10
240022	22
240026	26
240030	30
240036	36



Spatola forata

Design by Michele Capuani

Perforated spatula

Cod.	W x L cm
240300	7,5 x 16



Spatola angolare appuntita

Design by Michele Capuani

Tapered point angular spatula

Cod.	L cm
240011	11



Spatola per hamburger

Design by Michele Capuani

Hamburger turner

Cod.	W x L cm
240400	7 x 24
240401	14 x 19



Spatola diritta

Design by Michele Capuani

Spatula

Cod.	L cm
240112	12
240115	15
240120	20
240122	22
240126	26
240130	30
240136	36



Spatola per pizza

Design by Michele Capuani

Pizza turner

Cod.	W x L cm
240501	9 x 15,5



LE SPATOLE PROFESSIONALI: PERFETTE IN CUCINA, PIZZERIA, PASTICCERIA
THE PROFESSIONAL SPATULAS: PERFECT FOR RESTAURANTS, PIZZERIAS, PATISSERIES

**MANICO SPECIALE:
ERGONOMICO
E ANTISCIVOLO**

SPECIAL ERGONOMIC
NON-SLIP HANDLE



- LAMA IN ACCIAIO
- ROBUSTE, PRATICHE, FUNZIONALI
- AMPIA DISPONIBILITÀ DI FORME E DIMENSIONI: PIÙ DI 30 MODELLI
- ASOLA PER APPENDERLE PRESENTE SU TUTTA LA SERIE
- DESIGN ITALIANO

- STEEL BLADE
- STURDY, PRACTICAL, FUNCTIONAL
- WIDE RANGE OF SHAPES AND SIZES: MORE THAN 30 ITEMS
- ALL ITEMS HAVE PRACTICAL HANGING LOOPS
- ITALIAN DESIGN



Spatola triangolare

Design by Michele Capuani

Triangle spatula

Cod.	W x L cm
240208	8 x 12
240210	10 x 12
240212	12 x 12



Tagliapasta

Design by Michele Capuani

Dough cutter

Cod.	W x L cm
240600	16 x 12



Raschia

Design by Michele Capuani

Scraper

Cod.	W x L cm
240601	12 x 9,5
240640	15 x 7,5



Raschia

Design by Michele Capuani

Scraper

Cod.	W x L cm
240700	15 x 6



Paletta pizza ovale forata

Design by Michele Capuani

Oval perforated pizza turner

Cod.	W x L cm
240900	18 x 22



Paletta pizza ovale

Design by Michele Capuani

Oval pizza turner

Cod.	W x L cm
240901	18 x 22



Paletta pizza triangolare forata

Design by Michele Capuani

Triangle perforated pizza turner

Cod.	W x L cm
241000	12 x 16



Paletta pizza triangolare

Design by Michele Capuani

Triangle pizza turner

Cod.	W x L cm
241001	12 x 16



I NUOVI ACCESSORI PIZZERIA: SEMPLICI ED ELEGANTI
THE NEW PIZZERIA ACCESSORIES: SIMPLE AND ELEGANT

La nuova serie di accessori replica il look della collezione "Puntorosso", riprendendone il colore ed il pomolo terminale.

Grazie al design dell'Arch. Michele Capuani si farà notare sia sul banco della vostra pizzeria così come davanti al forno di casa.

- LAMA IN ACCIAIO INOX
- 100% MADE IN ITALY

The new series of accessories replicates the look of the 'Puntorosso' collection, echoing the same color and terminal knob. Thanks to Arch. Michele Capuani's design, it will draw attention both on your pizzeria counter and in front of your home oven.

- STAINLESS STEEL BLADE
- 100% MADE IN ITALY



Tronchetto tagliapizza

Design by Michele Capuani

Pizza cutter

Cod.	W x L cm
240800	14 x 6



Rotella tagliapizza

Design by Michele Capuani

Pizza wheel cutter

Cod.	Ø cm
241106	5,5
241110	10



Rotella tagliapizza da tavola

Design by Michele Capuani

Table pizza wheel cutter

Cod.	Ø cm
241306	6



NEW

241206



241209

Rotella tagliapizza

Design by Michele Capuani

Pizza wheel cutter

Cod.	Ø cm
241206	6
241209	9



LA TRAMA "PUNTINATA" IMPEDISCE AL CONDIMENTO DELLA PIZZA DI ATTACCARSI ALLA LAMA DURANTE IL TAGLIO
THE 'ALVEOLATED' TEXTURE PREVENTS PIZZA TOPS FROM STICKLING TO THE BLADE DURING CUTTING

NEW



Rotella tagliapizza bugnata

Design by Michele Capuani

Alveolate pizza wheel cutter

Cod.	Ø cm
241219	9



NEW

Forbici da pizza

Pizza scissors

Cod.
242001



NEW

Forbici da tavola

Table scissors

Cod.
242010





PASTICCERIA

PÂTISSERIE

MOLLE E PINZE PER DOLCI
PASTRY TONGS AND SCISSOR SERVERS 114

SACCAPOCHE E BOCCHETTE
PASTRY BAGS AND DECORATING NOZZLES 116

SPATOLE
SPATULAS 120

RULLI E PENNELLI
ROLLING PINS AND PASTRY BRUSHES 122

TAGLIAPASTA E TAGLIABISCOTTI
PASTRY AND BISCUIT CUTTERS 123

MISURINI E STAMPI
MEASURING CUPS AND MOULDS 127

STAMPI E FORME
MOULDS 128

ACCESSORI PASTICCERIA
PÂTISSERIE ACCESSORIES 132

**Molla per dolci**

Pastry tong	Cod.	L cm	Box
	010600	18	12

**Mollunga per toast e dolci**

Design by Michele Capuani

Buffet toast tong 'Mollunga'	Cod.	L cm	Box
	011000	30	12

**Molla per dolci**

Pastry tong	Cod.	L cm	Box
	011900	16,5	12

**Molla per toast e dolci**

Ice cube tong	Cod.	L cm	Box
	012500	21	12

**CONTROLLATE UNA AD UNA**
CHECKED ONE BY ONE

Tutte le nostre molle e pinze in acciaio inox sono interamente prodotte nei nostri stabilimenti. Grazie agli investimenti tecnologici la linea di produzione robotizzata ha ora una potenzialità produttiva di 6.000.000 di molle l'anno. Per diventare una molla PIAZZA però tutte, nessuna esclusa, devono passare l'ultimo esame, il più difficile, uno scrupoloso e certosino controllo manuale della loro precisione di chiusura e della loro straordinaria capacità di conservare l'elasticità nel tempo, una caratteristica questa, dovuta ad un passaggio produttivo che solo noi conosciamo e che ancora gelosamente custodiamo. Sarà per questo che qualcuno ci ha definito "King of Tongs"...

All our stainless steel tongs and scissor servers are produced entirely in our Italian factories. Thanks to investments in technology, our automated line now has production capacity of 6,000,000 tongs a year. However, to become a PIAZZA tong, all of them, without exception, must pass a final exam, the most difficult one: painstaking manual control of their closing accuracy and extraordinary ability to retain their spring over time. This last is a characteristic made possible thanks to a special step in the production process that is known to us alone and jealously guarded. Perhaps this is why we have been called the "King of Tongs"...





Pinza per dolci forgiata

Pastry scissor server

Cod.	L cm
020000	16,5



Pinza per torta forgiata

Pie scissor server

Cod.	L cm
020400	25



Pinza per dolci forgiata

Pastry scissor server

Cod.	L cm
020100	20



Pinza per dolci "Mignon" forgiata

Midget scissor server
'Mignon'

Cod.	L cm
020700	15



Pinza per dolci forgiata

Pastry scissor server

Cod.	L cm
020200	20
0202001	20



Cod. 0202001



Pinza per dolci "Mignon" forgiata

Midget scissor server
'Mignon'

Cod.	L cm
020800	15



Pinza per dolci forgiata

Pastry scissor server

Cod.	L cm
020300	21
0203001	21



Cod. 0203001



Pinza per forno

Hot plate holder

Cod.	L cm
021100	18,5





Saccapoche nylon "Superflex"

'Superflex' nylon pastry bags	Cod.	L cm	Box
	2751252	25	6
	2751282	28	6
	2751342	34	6
	2751402	40	6
	2751462	46	6
	2751502	50	6
	2751552	55	6
	2751602	60	6



Saccapoche nylon "Professionale"

'Professional' nylon pastry bags	Cod.	L cm	Box
	2753252	25	6
	2753282	28	6
	2753342	34	6
	2753402	40	6
	2753462	46	6
	2753502	50	6
	2753552	55	6
	2753602	60	6



Saccapoche monouso in polietilene a rotolo

Disposable pastry bags - one roll	Cod.	L cm	T μ
	275501	50	70
	275503	30	70
	275505	40	70



Set 3 saccapoche "Superflex"

3 different pastry bags "Superflex"	Cod.	L cm	Box
	275700	34 - 46 - 50	6





Bocchetta per decorazione acciaio inox foro a stella



Star decorating nozzle - stainless steel	Cod.	Ø mm
	2763022	2
	2763032	3
	2763042	4
	2763052	5
	2763062	6
	2763072	7
	2763082	8
	2763092	9
	2763102	10
	2763112	11
	2763122	12
	2763132	13
	2763142	14
	2763152	15
	2763162	16
	2763172	17
	2763182	18

Bocchetta per decorazione acciaio inox foro tondo



Plain decorating nozzle - stainless steel	Cod.	Ø mm
	2764022	2
	2764032	3
	2764042	4
	2764052	5
	2764062	6
	2764072	7
	2764082	8
	2764092	9
	2764102	10
	2764112	11
	2764122	12
	2764132	13
	2764142	14
	2764152	15
	2764162	16
	2764172	17
	2764182	18
	2764202	20
	2764222	22
	2764242	24



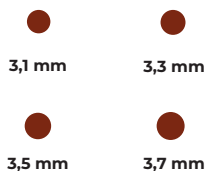

Set per alta decorazione: 4 bocchette foro tondo, portabocchette, saccapoché

Decoration set: 4 nozzles plain, nozzles ring, pastry bag Cod. **276501** L cm 34

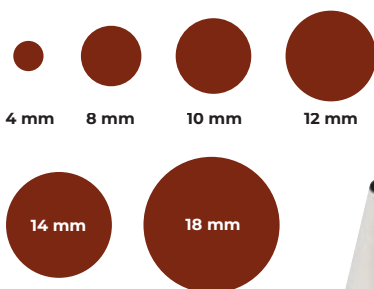

Set 6 bocchette inox foro tondo

Set of 6 stainless steel plain nozzles Cod. **276601**

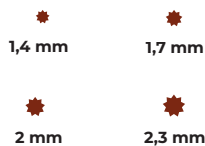

Set per alta decorazione: 4 bocchette foro stella, portabocchette, saccapoché

Decoration set: 4 nozzles star, nozzles ring, pastry bag Cod. **276502** L cm 34

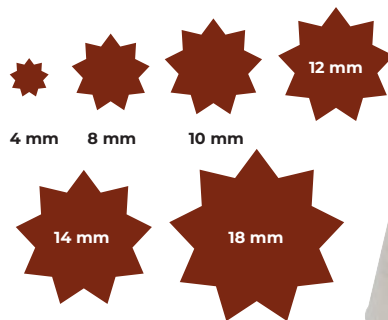

Set 6 bocchette inox foro stella

Set of 6 stainless steel star nozzles Cod. **276602**

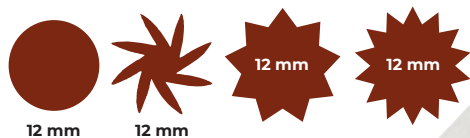

Set decorazione: 4 bocchette inox e saccapoché

Decoration set: 4 stainless steel nozzles + pastry bag Cod. **276603** L cm 34

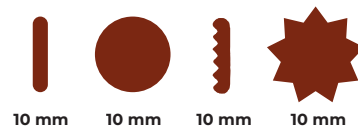

Set decorazione: 4 bocchette inox e saccapoché

Decoration set: 4 stainless steel nozzles + pastry bag Cod. **276604** L cm 34

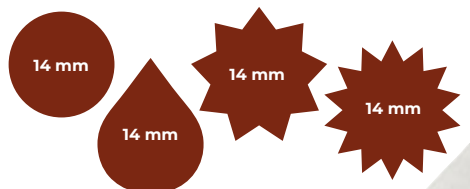

Set decorazione: 4 bocchette inox e saccapoché

Decoration set: 4 stainless steel nozzles + pastry bag Cod. **276605** L cm 34





Set 5 bocchette inox

Set of 5 stainless steel decorating nozzles

Cod. **276703**



Set 5 bocchette inox

Set of 5 stainless steel decorating nozzles

Cod. **276704**



25 mm



Bocchetta Saint-Honoré in acciaio inox

Saint-Honoré decorating nozzle stainless steel

Cod. **277200**



Cannoli cilindrici in latta

Tin cream cylindrical cornet moulds

Cod. **276801**

L cm	Ø cm	Box
13	2	6



Cannoli conici in latta

Tin cream cylindrical cornet moulds

Cod. **276802**

L cm	Ø cm	Box
12	3	6



Cassettina 12 bocchette polipropilene

Polypropylene 12 pcs - nozzles box

Cod. **276902**



Cassettina 12 bocchette polipropilene

Polypropylene 12 pcs - nozzles box

Cod. **276901**



Spatola professionale "Vasetto" in plastica

Professional plastic spatula for jar

Cod.	L cm
285000	25



Spatola taglia impasti in plastica

Cutter for pies and fat

Cod.	L cm	Box
285112	23	12



Spatola professionale in plastica

Professional plastic spatula

Cod.	L cm
285001	25
285002	35
285003	45



Set 7 spatole polipropilene

Polypropylene spatulas - 7 pcs

Cod.	Box
285123	10



Spatola professionale applicazione in silicone

Professional spatula with silicone blade

Cod.	L cm
285012	35



Spatolina in plastica

Scraper in polypropylene

Cod.	L x W cm	Box
285124	14,5 x 9,5	10
285125	12 x 8,5	10
285126	14,5 x 9,5	10
285127	12 x 9	10
285128	15 x 11	10



NEW

Spatola professionale in nylon rinforzato con fiberglass

Professional spatula in nylon reinforced with fiberglass

Cod.	L cm	Box
285021	30	6
285022	35	6
285023	40	6



Spatolina in plastica

Scraper in polystyrene - trapezoidal shape

Cod.	L x W cm	Box
285129	21,5 x 13	10



Spatola angolare

Design by Michele Capuani

Angular spatula

Cod.	L cm
240010	10
240022	22
240026	26
240030	30
240036	36



Spatola angolare appuntita

Design by Michele Capuani

Tapered point angular spatula

Cod.	L cm
240011	11



Spatola diritta

Design by Michele Capuani

Spatula

Cod.	L cm
240112	12
240115	15
240120	20
240122	22
240126	26
240130	30
240136	36



Spatola triangolare

Design by Michele Capuani

Triangle spatula

Cod.	W x L cm
240208	8 x 12
240210	10 x 12
240212	12 x 12



Rotella liscia

Design by Michele Capuani

Plain wheel cutter

Cod.	Ø cm
241106	5,5
241110	10



Rotella liscia

Design by Michele Capuani

Plain wheel cutter

Cod.	Ø cm
241206	6
241209	9



Rotella bugnata

Design by Michele Capuani

Alveolate wheel cutter

Cod.	Ø cm
241219	9



Rotella ondulata inox, manico plastica

Wheel fluted cutter - st. steel, plastic handle

Cod.	Ø cm
285219	5,5





Tagliapasta Design by Michele Capuani

Dough cutter Cod. W x L cm
240600 16 x 12



Raschia Design by Michele Capuani

Scraper Cod. W x L cm
240700 15 x 6



Raschia Design by Michele Capuani

Scraper Cod. W x L cm
240601 12 x 9,5
240640 15 x 7,5

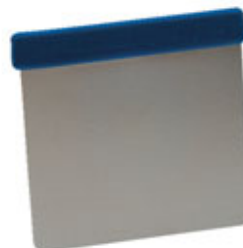

Raschietto inox flessibile

Flexible stainless steel desk cleaner Cod. L cm Box
285131 12 6



Rullo bucasfoglia in plastica

Plastic roller with spikes Cod. L cm
285302 12



Rullo losanghe in plastica

Plastic lozenge cutter Cod. L cm
285304 6,5
285305 12



Pennello

Baker brush Cod. L cm Box
285401 4 12
285402 6 12



Pennello pasticceria

Pastry brush Cod. L cm Box
285405 2 12
285406 2,5 12
285409 4 12
285410 5 12
285411 6 12
285412 8 12
285413 10 12



Pennello pasticceria

Pastry brush Cod. L cm Box
285415 4 12



Tagliapasta a cuore

Cake cutter - heart

Cod. **285520** Ø cm 6



Scatola 12 tagliapasta in latta, piccoli

Box of 12 pastry cutters in tin - little

Cod. **285526** L cm 1,5



Set 10 tagliapasta assortiti in latta

Tin pastry cutters - different shapes 10 pcs

Cod. **285521** Ø cm 6



Scatola 6 tagliabiscotti a cuore in latta

Box of 6 biscuit cutters in tin - heart

Cod. **285527**



Scatola 14 tagliapasta lisci in latta

Different tin pastry cutters - plain

Cod. **285523** Ø cm 2 → 11



Scatola 6 tagliabiscotti a rosa in latta

Box of 6 biscuit cutters in tin - rose

Cod. **285528**



Set 6 tagliabiscotti a goccia in latta

Set of 6 biscuit cutters in tin - drop

Cod. **285524**



Scatola 6 tagliabiscotti a mezza luna in latta

Box of 6 biscuit cutters in tin - half moon

Cod. **285530**



Scatola 12 tagliapasta in latta, grandi

Box of 12 pastry cutters in tin - big

Cod. **285525**





Tagliabiscotti a pesce piccolo in latta

Fish shaped biscuit cutter in tin - little

Cod.	L x W cm
285531	7,5 x 5



Set 6 tagliabiscotti a trifoglio in latta

Set of 6 biscuit cutters in tin - shamrock

Cod.	
285535	



Set 12 tagliabiscotti ad anello frastagliato in latta

Set of 12 indented ring biscuit cutters in tin

Cod.	
285532	



Set 6 tagliabiscotti a stella in latta

Set of 6 biscuit cutters in tin - star

Cod.	
285536	



Set 6 tagliabiscotti a quadrato lisci in latta

Set of 6 biscuit cutters in tin - plain square

Cod.	
285533	



Set 5 tagliabiscotti a quadrato festonati in latta

Set of 5 biscuit cutters in tin - festooned square

Cod.	
285537	



Set 6 tagliabiscotti ad esagono in latta

Set of 6 biscuit cutters in tin - hexagon

Cod.	
285534	



Set 6 tagliabiscotti ovali in latta

Set of 6 biscuit cutters in tin - oval

Cod.	
285538	



Scatola tagliapasta lettere (26 pezzi) in latta

Pastry cutters in tin: alphabet (26 pcs)

Cod.	
285554	



Scatola tagliapasta mezzi di trasporto (5 pezzi) in latta

Pastry cutters in tin: vehicles (5 pcs.)

Cod.	
285557	



Tagliapasta cerchio liscio in latta con manico

Round pastry cutter in tin with handle, plain : Cod. 285563 Ø cm 6 H cm 3



Tagliapasta cerchio festonato in latta con manico

Round pastry cutter in tin with handle, serrated : Cod. 285564 Ø cm 6 H cm 4



Tagliapasta cerchio liscio in latta

Round pastry cutter in tin with handle, plain : Cod. 285565 Ø cm 10 H cm 3



Tagliapasta inox dentellata

Stainless steel pastry cutter, serrated : Cod. 285569 Ø cm 12



Tagliapasta inox liscia

Stainless steel pastry cutter, plain : Cod. 285570 Ø cm 12



Set 12 tagliapasta inox cerchio dentellato

Pastry cutter ring, serrated (set of 12 pcs.) : Cod. 285571 Ø cm 3 → 14



Set 9 tagliapasta inox cuore dentellato

Pastry cutter heart, serrated (set of 9 pcs.) : Cod. 285572 Ø cm 6 → 14



Set 9 tagliapasta inox stella liscia

Pastry cutter star, plain (set of 9 pcs.) : Cod. 285574 Ø cm 3,7 → 15



Set 9 tagliapasta praline inox

Stainless steel praline cutters (set of 9 pcs.) : Cod. 285575 L x W cm 3,5 x 2 - 2,5 x 2,5 - 4 x 2,6 3 x 1,5 - 3,5 x 3 - 4 x 2 2 x 2,3 - 3,5 x 1,8 - Ø2,6



Set 4 tagliapasta assortiti in latta

Set of 4 pcs. pastry cutter in tin : Cod. 285598 L x W cm 8 x 6 H cm 3 Box 6

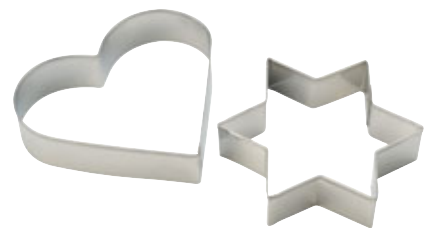

Set 2 tagliapasta assortiti in latta

Set of 2 pcs. pastry cutter in tin : Cod. 285599 L x W cm 12 x 12 H cm 3 Box 6



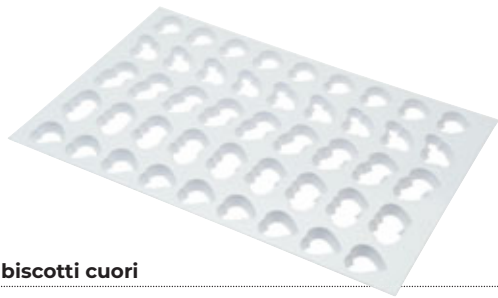

Griglia tagliabiscotti cuori

Sheet of cutters:
hearts

Cod.	L x W cm	H cm
285600	60 x 40	2



Griglia tagliabiscotti mezzi di trasporto

Sheet of cutters:
vehicles

Cod.	L x W cm	H cm
285601	60 x 40	2

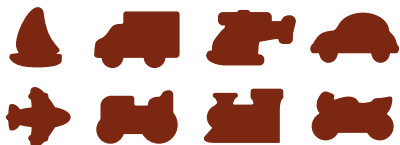

Griglia tagliabiscotti strumenti musicali

Sheet of cutters:
musical instruments

Cod.	L x W cm	H cm
285602	60 x 40	2



Busta per cuoco in carta

Low forage hat

Cod.	H cm	Box
290300	8,5	30



Cappello da cuoco standard in carta

Pleated hat - standard

Cod.	H cm	Box
290400	21,6	10



Sessola in plastica

Flour scoop
in polypropylene

Cod.	L cm	Box
290619	19	6
290625	25	6
290631	31	6
290635	35	6
290640	40	6



Misurino in plastica

Measuring cup	Cod.	lt	Box
	290702	0,25	6
	290705	0,5	6
	290710	1	6
	290720	2	
	290730	3	
	290750	5	

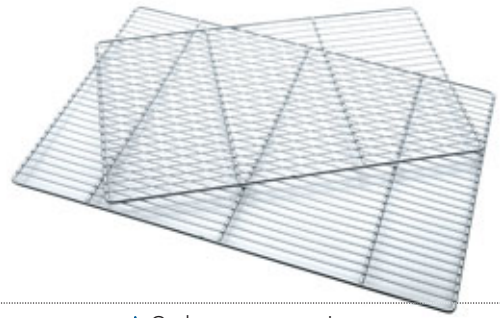

Griglia inox

Flat rack	Cod.	L cm
	291053	53 x 32,5 GN 1/1
	291060	60 x 40
	291065	65 x 53 GN 2/1



NEW



Misurino in plastica con manico aperto

Measuring cup with open handle	Cod.	lt
	290805	0,5
	290810	1
	290820	2
	290830	3
	290850	5

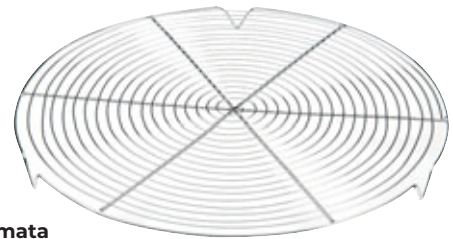

Griglia tonda cromata con piedini

Cake cooling tray with feet	Cod.	Ø cm
	291066	36



NEW



Coperchio per misurino in plastica

Lid for measuring cup	Cod.	lt
	290905	0,5
	290910	1
	290920	2
	290930	3
	290950	5



Kit 2 stampi semifreddo rettangolari in plastica

Kit of 2 pcs. plastic semifreddo mould, rectangular	Cod.	L x W cm	H cm	Box
	291402	16 x 32,5 15 x 26,5	5,5 4,5	6



Kit 2 stampi semifreddo quadrati in plastica

Kit of 2 pcs. plastic semifreddo mould, square	Cod.	L x W cm	H cm	Box
	291407	28,5 x 24 24,5 x 20	5,5 4,5	6





Stampo cassata in alluminio

Aluminium cassata mould	Cod.	Ø cm	H cm
	291612	12	10
	291613	13	10,7



Stampo cassata conico in alluminio

Aluminium conical cassata mould	Cod.	Ø cm	H cm
	291614	10	10



Stampo zuccotto in alluminio

Aluminium 'Zuccotto' mould	Cod.	Ø cm	H cm
	291615	23	10,5



Tortiera conica alta silverstone in alluminio antiaderente

Silverstone high conical cake tin in aluminium with non stick coating	Cod.	Ø cm	H cm
	291924	24	6,2



Stampo tartelletta tondo dritto in alluminio antiaderente

Canapé mould round straight in aluminium with non stick coating	Cod.	Ø cm	H cm
	292070	7	1,8



Stampo barchetta in alluminio antiaderente

Boat mould in aluminium with non stick coating	Cod.	L x W cm	H cm
	292299	10 x 4,3	1,3



Stampo conico festonato in alluminio

Aluminium "Brioche" mould	Cod.	Ø cm	H cm
	2923134	12	6



Stampo conico festonato in alluminio

Aluminium "Brioche" mould	Cod.	Ø cm	H cm
	292320	20	8



Stampo conico festonato alto in alluminio

Aluminium "Brioche" mould	Cod.	Ø cm	H cm
	292413	13	10



Stampo diamante in alluminio

Aluminium "Diamond" mould	Cod.	Ø cm	H cm
	292920	20	10





Photo by Depositphotos

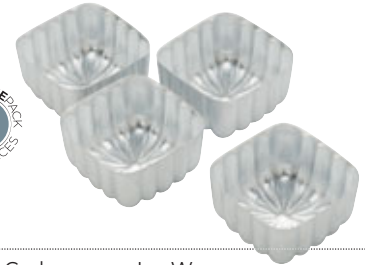

Stampo budino senza orlo quadro in alluminio

Aluminium square pudding mould

Cod.	L x W cm
2936074	7 x 7



Stampo budino s/orlo conico liscio in alluminio

Aluminium plain bottom pudding mould

Cod.	Ø cm	H cm
2933084	8	5



Stampo bocconotto slabbrato in alluminio

Aluminium chipped rim oval pastry mould

Cod.	L x W cm	H cm
2938104	10 x 7	2



Stampo monodose festonato in alluminio

Aluminium conical shaped mould

Cod.	Ø cm	H cm
2934084	8	8



Stampo bocconotto alto in alluminio

Aluminium high pastry mould

Cod.	Ø cm	H cm
2940074	7	3,5



Stampo babà con orlo in alluminio

Aluminium rimmed babà

Cod.	Ø cm	H cm
2935084	8	9



Set 6 stampini pasticceria in alluminio

Kit of 6 pcs aluminium pastry moulds

Cod.	L x W cm
294299	6,5 x 4,5





Stampo brioche alto antiaderente

Non sticking high fluted brioche mould

Cod.	Ø cm	H cm
2952806	8	4



Tortiera tonda bassa lamiera blu

Blue steel low round baking-pan

Cod.	Ø cm	H cm	Box
252522	22	2,5	6
252524	24	2,5	6
252526	26	2,5	6



Stampo ovale festonato antiaderente

Non sticking oval shaped mould

Cod.	L x W cm	H cm
2953104	10 x 4	4



Savarin bucata antiaderente

Non sticking savarin mould

Cod.	Ø cm	H cm
2958026	8	4



Stampo madeleines multiplo antiaderente

Non sticking multiple madeleines mould

Cod.	L x W cm	H cm
295400	36 x 17	2



Diplomate/bavarois antiaderente

Non sticking bavarois

Cod.	Ø cm	H cm
296002	18	9



Set 4 stampini pasticceria antiaderente

Kit of 4 pcs non sticking small pastry moulds

Cod.	H cm
295500	1,5





Placca pasta roll. bordata in alluminio antiaderente

Baking plate in aluminium with non stick coating	Cod.	L x W cm	H cm
	296004	37 x 27	2



Forma per torta manqué antiaderente

Non sticking square mould	Cod.	L x W cm	H cm
	296008	22 x 22	5



Savarin bucata antiaderente

Non sticking savarin mould	Cod.	Ø cm	H cm
	296005	24	5



Forma tonda scanalata bassa antiad. fondo mobile

Non sticking round mould, fluted edges, loose bottom	Cod.	Ø cm	H cm
	296242	30	3,5
	296250	32	3,5



Forma savarin con spirali antiaderente

Non sticking "trois freres" ring mould	Cod.	Ø cm	H cm
	296006	22	5

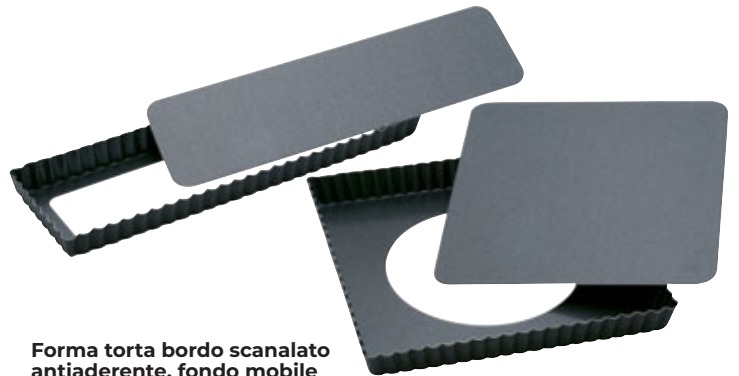

Forma torta bordo scanalato antiaderente, fondo mobile

Non sticking mould, fluted, loose bottom	Cod.	L x W cm	H cm
	296410	23 x 23	2,5
	296910	35 x 11	2,5



Forma per torta manqué antiaderente

Non sticking square mould	Cod.	L x W cm	H cm
	296007	24 x 24	5

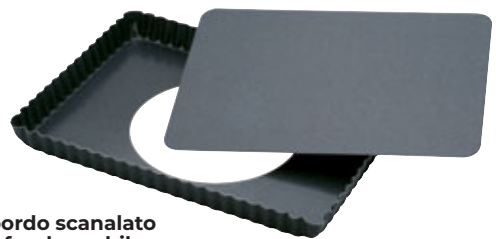

Forma torta bordo scanalato antiaderente, fondo mobile

Non sticking mould, fluted, loose bottom	Cod.	L x W cm	H cm
	298110	20,5 x 29	2,5





Alzata girevole in plastica per decorazione torte

Revolving cake stand, plastic

Cod.	Ø cm	H cm
298200	32	11



Spatola flessibile poliamide antiaderente

Non sticking spatula

Cod.	L x W cm	Box
298210	34 x 9	12

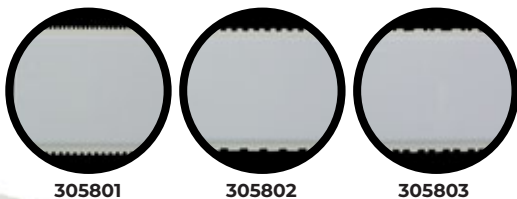

Pettine per decorazioni in plastica

Plastic comb for decoration

Cod.	L cm
305801	70
305802	70
305803	70



1. SPATOLARE IN MANIERA UNIFORME LA PASTA PER LA DECORAZIONE SUL TAPPETO ANTIADERENTE
SPREAD THE DECORATION PASTRY UNIFORMLY ON THE NON-STICK MAT



2. APPOGGIARE IL PETTINE PER LA DECORAZIONE SUL FOGLIO E, TIRANDOLO NELLA DIREZIONE DESIDERATA, CREARE IL DECORO. PASSARE IN CONGELATORE
REST THE DECORATING COMB ON THE SHEET AND CREATE THE DECORATION BY DRAWING IT IN THE DESIRED DIRECTION. PUT INTO THE FREEZER



3. STENDERE IN MANIERA UNIFORME LA PASTA PER IL BISCUIT. CUOCERE IN FORNO
SPREAD THE BISCUIT PASTRY UNIFORMLY. BAKE IN THE OVEN



4. TOGLIERE, CON DELICATEZZA, IL TAPPETO ANTIADERENTE
CAREFULLY REMOVE THE NON-STICK MAT



5. CON GLI APPOSITI TAGLIAPASTA REGOLABILI TAGLIARE IL PRODOTTO, CREANDO LE FASCE DI BISCUIT DELLA LARGHEZZA DESIDERATA
WITH THE SPECIAL ADJUSTABLE CUTTERS, CUT THE PRODUCT, CREATING BISCUIT STRIPS OF THE DESIRED WIDTH



Diplomate/bavarois ferro bianco

Tin plate diplomate mould

Cod.	Ø cm	H cm	Box
298410	16	9	3



306808



306810

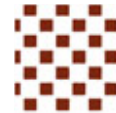

306811



306812



306814



306817



Griglia in plastica per decorazione biscuit

Plastic grill for decorated biscuit

Cod.	L x W cm
306808	60 x 40
306810	60 x 40
306811	60 x 40
306812	60 x 40
306814	60 x 40
306817	60 x 40



Imbuto colatore inox manico e supporto in plastica

Automatic piston funnel - with plastic handle and stand

Cod.	Ø cm	Lt
305300	20	0,9

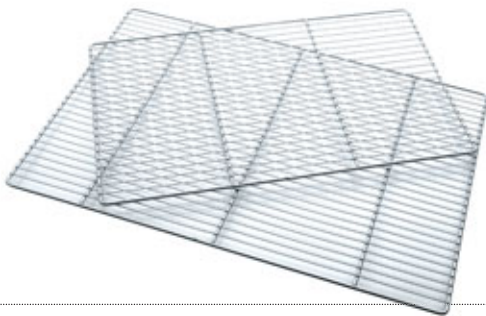

Griglia inox

Flat rack

Cod.	L cm
291053	53 x 32,5 GN 1/1
291060	60 x 40
291065	65 x 53 GN 2/1



Foglio pretagliato neutro

Precut paper

Cod.	L x W cm
306600	60 x 40



1. POSIZIONARE LA GRIGLIA SOPRA IL TAPPETO ANTIADERENTE E SPATOLARE IN MANIERA UNIFORME LA PASTA PER LA DECORAZIONE

POSITION THE GRILLE ABOVE THE NON-STICK MAT AND UNIFORMLY SPREAD THE PASTRY FOR DECORATION



2. SOLLEVARE CON DELICATEZZA LA GRIGLIA, LA VOSTRA DECORAZIONE È PRONTA PER ESSERE POSTA NEL CONGELATORE

GENTLY RAISE THE GRILLE. YOUR DECORATION IS READY TO BE PLACED IN THE FREEZER



Alzata per dolci

Cake stand	Cod.	Ø cm	H cm
	420424	24	9



Espositore per torta

Cake stand	Cod.	Ø cm	H cm
	420507	20	7
	420511	20	11
	420515	20	15
	420607	25	7
	420611	25	11
	420615	25	15
	420707	30	7
	420711	30	11
	420715	30	15



Anello inox tondo

Stainless steel mousse ring	Cod.	Ø cm	H cm
	701410	10	4
	701412	12	4
	701414	14	4
	701418	18	4
	701420	20	4
	701422	22	4
	701426	26	4
	701428	28	4
	701430	30	4



Quadrato inox

Stainless steel square	Cod.	Ø cm	H cm
	705418	18 x 18	4
	705420	20 x 20	4
	705422	22 x 22	4
	705424	24 x 24	4
	705426	26 x 26	4
	705428	28 x 28	4





TAVOLA

TABLEWARE

LINEE POSATERIA
CUTLERY LINES

138

POSATERIA SPECIALE
SPECIAL CUTLERY

144

VASSOI
TRAYS

146

COMPLEMENTI TAVOLA
TABLE COMPLEMENTS

148



310001



310021



310031



310002



310022



310033



310003



310023



310034



310004

Parigi



	Cod.	L cm	T mm
Cucchiaio tavola Table spoon	310001	20,6	3
Cucchiaio frutta Dessert spoon	310002	18	3
Cucchiaino thé e caffè Tea spoon	310003	14	3
Cucchiaino moka Moka spoon	310004	11,5	3
Forchetta tavola Table fork	310021	20,6	3
Forchetta frutta Dessert fork	310022	18	3
Forchetta pesce Fish fork	310023	18	3
Coltello tavola Table knife	310031	23,8	3
Coltello frutta Dessert knife	310033	21	3
Coltello pesce Fish knife	310034	21	3



IL CODICE IN COLORE INDICA CHE LA CONFEZIONE CONTIENE 12 PEZZI
THE COLOR CODE INDICATES THAT THE PACKAGE CONTAINS 12 PIECES



310101



310121



310131



310102



310122



310133



310103



310123



310134



310104



310124



310150

Vienna

	Cod.	L cm	T mm
Cucchiaino moka Moka spoon	310104	11,5	3
Cucchiaino thé e caffè Tea spoon	310103	14	3
Cucchiaino frutta Dessert spoon	310102	18	3
Cucchiaio tavola Table spoon	310101	20,6	3
Forchettina torta Cake fork	310124	16,5	3
Forchetta frutta Dessert fork	310122	18	3
Forchetta pesce Fish fork	310123	18	3
Forchetta tavola Table fork	310121	20,6	3
Coltello tavola Table knife	310131	23,8	3
Coltello frutta Dessert knife	310133	21	3
Coltello pesce Fish knife	310134	21	3
Pala torta Cake server	310150	26	3



IL CODICE IN COLORE INDICA CHE LA CONFEZIONE CONTIENE 12 PEZZI
THE COLOR CODE INDICATES THAT THE PACKAGE CONTAINS 12 PIECES

PIAZZA



310201



310202



310203



310204



310207



310221



310222



310223



310224



310231



310233



310234



310235



310236



310250



310251



310252



310253



310254



310255

Roma



	Cod.	L cm	T mm
Cucchiaino tavola Table spoon	310201	20,6	3
Cucchiaino frutta Dessert spoon	310202	18	3
Cucchiaino thé e caffè Tea spoon	310203	14	3
Cucchiaino moka Moka spoon	310204	11,5	3
Cucchiaino bibita Cocktail spoon	310207	20	3
Forchetta tavola Table fork	310221	20,6	3
Forchetta frutta Dessert fork	310222	18	3
Forchetta pesce Fish fork	310223	18	3
Forchettina torta Cake fork	310224	16,5	3
Coltello tavola Table knife	310231	23,8	3
Coltello frutta Dessert knife	310233	21	3
Coltello pesce Fish knife	310234	21	3
Spalmaburro Butter spreader	310235	17	3
Coltello bistecca Steak knife	310236	25	3
Pala torta Cake server	310250	26	3
Cucchiaino legumi Vegetable spoon	310251	23	3
Forchettone legumi Vegetable fork	310252	23	3
Posate insalata Salad servers	310253	23	3
Mestolo a servire Serving ladle	310254	27	3
Mestolo salsa Gravy ladle	310255	17,7	3



IL CODICE IN COLORE INDICA CHE LA CONFEZIONE CONTIENE 12 PEZZI
THE COLOR CODE INDICATES THAT THE PACKAGE CONTAINS 12 PIECES



310301



310302



310303



310304



310321



310322



310323



310324



310331



310333



310334



310336



310350



310351



310352

Copenhagen

Design by Michele Capuani

	Cod.	L cm	T mm
Cucchiaino tavola Table spoon	310301	20,6	3
Cucchiaino frutta Dessert spoon	310302	18,7	3
Cucchiaino thé e caffè Tea spoon	310303	15	3
Cucchiaino moka Moka spoon	310304	12,3	3
Forchetta tavola Table fork	310321	20,6	3
Forchetta frutta Dessert fork	310322	18,6	3
Forchetta pesce Fish fork	310323	19,1	3
Forchettina torta Cake fork	310324	16,5	3
Coltello tavola Table knife	310331	23,2	3
Coltello frutta Dessert knife	310333	21	3
Coltello pesce Fish knife	310334	21,3	3
Coltello bistecca Steak knife	310336	24,2	3
Pala torta Cake server	310350	26,5	3
Cucchiaione legumi Vegetable spoon	310351	26	3
Forchettone legumi Vegetable fork	310352	26	3



IL CODICE IN COLORE INDICA CHE LA CONFEZIONE CONTIENE 12 PEZZI
THE COLOR CODE INDICATES THAT THE PACKAGE CONTAINS 12 PIECES



ALLAN BAY TABLEWARE COLLECTION



La conoscenza di Allan Bay sulle tendenze e sull'evoluzione della ristorazione, si unisce all'esperienza produttiva di Piazza per creare una speciale collezione tavola. Sette pezzi, tutti rigorosamente in acciaio inox 18/10, che risolvono perfettamente ogni utilizzo di qualunque "mise en place", dalla tradizionale sino alla più moderna.

Allan Bay's understanding of current trends and evolution of restaurant meets Piazza's production skills to create a special collection of tableware.

Seven pieces that perfectly fits all your 'mise en place' needs, from the traditional to the most modern.

NEW**La Molla "Allan Bay"**

'Allan Bay' tongs

Cod.

013000

Box

6

**NEW**
 CONFEZIONE
6
 PEZZI/PIECES
La Forchetta "Allan Bay"

'Allan Bay' fork

Cod.

315025**NEW**
 CONFEZIONE
6
 PEZZI/PIECES
La Spatola "Allan Bay"

'Allan Bay' spatula

Cod.

315035**NEW**
 CONFEZIONE
6
 PEZZI/PIECES
Il Coltello "Allan Bay"

'Allan Bay' knife

Cod.

315036**NEW**
 CONFEZIONE
6
 PEZZI/PIECES
Il Salsacoltello "Allan Bay"

'Allan Bay' cutting spoon

Cod.

315056**NEW**
 CONFEZIONE
6
 PEZZI/PIECES
Il Cucchiaino "Allan Bay"

'Allan Bay' spoon

Cod.

315060**NEW****Il Vassoietto "Allan Bay"**

'Allan Bay' tray

Cod.

315090





Pala per torta a coltello unipezzo

Decorated pie server Cod. L cm
 320000 31



Pala per torta triangolare manico bianco

Pie server white handle Cod. L cm
 3205001 25



Pala per torta unipezzo

Decorated pie server Cod. L cm
 320200 30



Pala per torta triangolare

Pie server Cod. L cm
 320600 25



Pala per torta a lama dentellata unipezzo

Serrated decorated pie server Cod. L cm
 320300 30



Pala per pasta al forno

Gratin server Cod. L cm
 320800 29
 3208001 29



Cod. 3208001





Cucchiaine per servire

Serving spoon	Cod.	L cm	Finitura/Finishing
	320900	26	Lucido/Bright
	320901	26	Lucido ornato/Bright decorat.
	320902	26	Satinato ornato/Matt decorat.



Forchetta per ostrica

Oyster fork	Cod.	L cm
	321500	15



Posate per insalata

Salad servers	Cod.	L cm
	3211001	27,5



Forchetta scavino per aragosta

Lobster pick	Cod.	L cm
	321600	20



Mestolino per sugo, tipo normale

Sauce ladle	Cod.	L cm
	321200	16



Pinza per aragosta

Lobster pincer	Cod.	L cm
	321700	18,5



Mestolino per sugo con separatore grasso/magro

Sauce ladle fat separator	Cod.	L cm
	321201	16



Cucchiaino per marmellata

Jam spoon	Cod.	L cm
	321800	19



Forchettina per lumache

Snail fork	Cod.	L cm
	321400	14



Cucchiaino per bibita

Beverage spoon	Cod.	L cm
	321900	20





Vassoio rettangolare per bar in acciaio

Rectangular steel bar tray

Cod.	L x W cm
360025	25 x 19,5
360029	29 x 22
360034	34 x 27
360040	40 x 32
360046	46 x 35
360052	52 x 38
360060	60 x 45



Vassoio rettangolare per bar in acciaio con maniglie

Rectangular steel bar tray with handles

Cod.	L x W cm
360240	40 x 32
360246	46 x 35
360252	52 x 38
360260	60 x 45



Vassoio ovale per bar in acciaio

Oval steel bar tray

Cod.	L x W cm
360419	19 x 14
360423	23 x 18
360426	26 x 20



Vassoio rettangolare laminato antiscivolo

Rectangular laminated tray with non slip treatment

Cod.	L x W cm	Box
361000	37 x 53 EN	12
361100	32,5 x 53 GN 1/1	12
361200	36 x 46	12
361300	32 x 44	12
361400	33 x 43	12
361500	24,5 x 34	12
361600	28 x 20	12



Vassoio rettangolare laminato

Rectangular laminated tray

Cod.	L x W cm	Box
361001	37 x 53 EN	12
361101	32,5 x 53 GN 1/1	12
361201	36 x 46	12
361501	24,5 x 34	12



Vassoio trapezoidale laminato antiscivolo

Trapezoidal laminated tray with non slip treatment

Cod.	L x W cm	Box
362500	36 x 52	12



Vassoio trapezoidale laminato

Trapezoidal laminated tray

Cod.	L x W cm	Box
362501	36 x 52	12



Vassoio trapezoidale laminato antiscivolo

Trapezoidal laminat. tray with non slip treatment

Cod.	L x W cm	Box
362600	33 x 47	12





Vassoio ovale laminato antiscivolo

Oval laminated tray with non slip treatment	Cod.	L x W cm	Box
	363000	27 x 38	12
	363100	20 x 26,5	12



Vassoio rettangolare Rubberform antiscivolo

Rectangular Rubberform tray with non slip treatment	Cod.	L x W cm	Box
	366001	37 x 53 EN	12
	366101	32,5 x 53 GN 1/1	12
	366201	36 x 46	12
	366301	33 x 43	12
	366401	20 x 28	12
	366501	26,5 x 32,5 GN 1/2	12



Vassoio rotondo laminato antiscivolo

Round laminated tray with non slip treatment	Cod.	Ø cm	Box
	363500	43	12
	363600	38	12
	363700	32	12



Vassoio ovale Rubberform antiscivolo

Oval Rubberform tray with non slip treatment	Cod.	L x W cm	Box
	367001	21 x 29	12
	367101	20 x 26,5	12
	367301	44 x 58	12



Vassoio rettangolare KAU Polyform antiscivolo

Rectangular KAU Polyform tray with non slip treatment	Cod.	L x W cm	Box
	364000	37 x 53 EN	12
	364100	32,5 x 53 GN 1/1	12



Vassoio rotondo Rubberform antiscivolo

Round Rubberform tray with non slip treatment	Cod.	Ø cm	Box
	367501	43	12
	367601	38	12
	367701	32	12



Vassoio rotondo KAU Polyform antiscivolo

Round KAU Polyform tray with non slip treatment	Cod.	Ø cm	Box
	365500	36	12



Vassoio rettangolare in poliestere rinforzato

Oval reinforced tray in polyester	Cod.	L x W cm	Box
	368000	37 x 53 EN	12
	368300	26,5 x 32,5 GN 1/2	12



Vassoio ovale in poliestere rinforzato

Oval reinforced tray in polyester	Cod.	L x W cm	Box
	368500	21 x 29	12



Servizio per olio, aceto, sale, pepe, stecchi in filo

Condiment set 5 pcs - wire handle
Cod. **330000**



Servizio per olio, aceto, sale, pepe in filo

Condiment set 4 pcs - wire handle
Cod. **330100**



Servizio olio e aceto in filo

Oil & vinegar set 2 pcs - wire handle
Cod. **330200**



Servizio per sale e pepe in filo

Salt & pepper set 2 pcs - wire handle
Cod. **330300**



Servizio per sale, pepe, stecchi in filo

Salt/pepper/toothpick set - wire handle
Cod. **330400**



Formaggiera in filo

Parmesan cheese cellar
Cod. **330500**



Tappi olio, aceto, spargisale, spargipepe

Oil, vinegar, salt and pepper caps
Cod. **330700**
330800
330900



Box
4
4
4

Portastecchi

Toothpick holder
Cod. **331100**



Vetro formaggiera, vetro olio e aceto, vetro sale e pepe

Cheese cellar glass, oil and vinegar glass, salt and pepper glass
Cod. **331200**
331300
331400



Box
6
6
12



Tappo versatore aceto e olio

Vinegar and oil pourer
Cod. **331500**
331600



Box
4
4



NEW

Forbici da tavola

Table scissors

Cod.
242010



NEW

Rotella tagliapizza da tavola

Table pizza wheel cutter

Cod.
241306

Design by Michele Capuani

Ø cm
6



Tagliatartufi inox classico lama dritta

Truffle-slicer, stainless steel plain blade - classic

Cod.
375100



Tagliatartufi inox manico ulivo lama ondulata

Truffle-slicer, stainless steel corrugated blade, olive handle

Cod.
375500



NEW

Bacchette

Chopsticks

Cod.
325001-BL
325002-NE
325003-GR
325004-OR

Col.

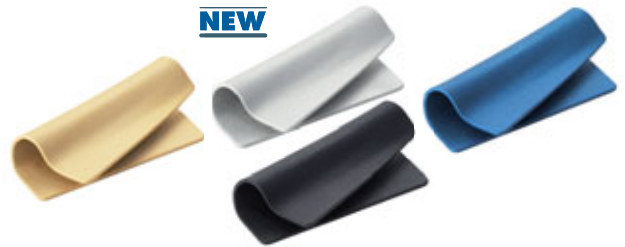

NEW

Base per bacchette

Chopstick rest

Cod.
325011-BL
325012-NE
325013-GR
325014-OR

Col.



NEW

Grattugia

Grater

Cod.
325021-BL
325022-NE
325023-GR
325024-OR

Col.





BAR

MOLLE BAR - TAPPI VERSATORI BAR TONGS - POURERS	152
VASSOI BAR BAR TRAYS	156
CAFFETTERIA - GELATERIA COFFEE AND TEA POTS - ICE CREAM SHOP	158
SHAKER, COLINI, MIXING GLASS SHAKERS, STRAINERS, MIXING GLASSES	162
JIGGERS	166
PESTELLI, SESSOLE, CUCCHIAI PESTLES, ICE SCOOPS, MIXING SPOONS	168
MUGS	170
ACCESSORI BAR BAR ACCESSORIES	173
APPARECCHI ELETTRICI ELECTRICAL APPLIANCES	186



Molla per ghiaccio

Ice cube tongs	Cod.	L cm	Box
	010400	18	12



Molla frutta

Design by Michele Capuani

Fruit tongs	Cod.	L cm	Box
	014500	30	12
	014515	15	12
	014523	23,5	12
	014540	40	12



Molla per ghiaccio

Ice cube tongs	Cod.	L cm	Box
	011100	20	12



Molla frutta 40°

Design by Michele Capuani

40° fruit tongs	Cod.	L cm	Box
	014600	30	12
	014615	15	12
	014623	23,5	12



Molla per ghiaccio

Ice cube tongs	Cod.	L cm	Box
	011500	16	12



Molla frutta in nylon & fiberglass

Design by Michele Capuani

Nylon & fiberglass fruit tongs	Cod.	L cm	Box
	01833000	30	12



Tappo versatore con silicone Design-Pourer

Design by Marco Valente

Design-Pourer silicone gear	Cod.
	050800



ADATTO A
SUITABLE FOR
Ø mm 17,5 > 18



Tappo versatore con silicone Tech-Pourer

Design by Marco Valente

Tech-Pourer silicone gear	Cod.
	0509004



ADATTO A
SUITABLE FOR
Ø mm 17,5 > 18



Tappo versatore con silicone Tech-Pourer

Design by Marco Valente

Tech-Pourer silicone gear	Cod.
	0510004



ADATTO A
SUITABLE FOR
Ø mm 17,5 > 18



Tappo versatore con silicone Tech-Pourer

Design by Marco Valente

Tech-Pourer silicone gear	Cod.
	0511004



ADATTO A
SUITABLE FOR
Ø mm 17,5 > 18



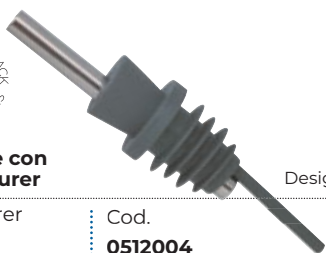

ADATTO A
SUITABLE FOR
Ø mm 17,5 > 18



Design by Marco Valente

Tappo versatore con silicone Soft-Pourer

Pourer Soft-Pourer

Cod. 0512004



NEW

ADATTO A
SUITABLE FOR
Ø mm 17,5 > 18

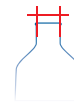

Tappo versatore dosatore inox con cappuccio

Measuring stainless steel pourer with closure cap

Cod. 0532552

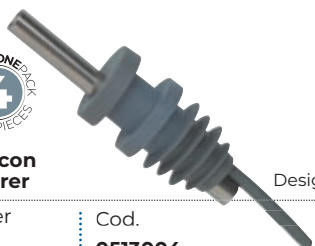

ADATTO A
SUITABLE FOR
Ø mm 17,5 > 18



Design by Marco Valente

Tappo versatore con silicone Soft-Pourer

Pourer Soft-Pourer

Cod. 0513004



ADATTO A
SUITABLE FOR
Ø mm 17,5 > 18



Tappo versatore dosatore inox con chiusura

Measuring stainless steel pourer with lid

Cod. 05325012



ADATTO A
SUITABLE FOR
Ø mm 17,5 > 18

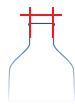

Design by Marco Valente

Tappo versatore per vino con chiusura

Closable wine-pouring stopper

Cod. 051800

Box 18



Tappo versatore continuo

Design by Marco Valente

Continuous pourer

Cod.

Col.

Box

05350112

●

4

05350312

●

4

05350412

●

4

05350612

●

4



ADATTO A
SUITABLE FOR
Ø mm 17,5 > 18



Tappo versatore dosatore in acciaio inox

Measuring stainless steel pourer

Cod. 05321012



BPour, tester per dosaggi

BPour, pour check

Cod. 053290

Ø cm 10,5

H cm 16,5



Tappo versatore metrico

Metric pourer

Cod.

ml

Col.

0540153

15

●

0540203

20

●

0540253

25

●

0540303

30

●

0540353

35

●

0540403

40

●

0540503

50

●





Cod. 0533002



Cod. 0533006

ADATTO A
SUITABLE FOR
Ø mm 18,5 > 21**Tappo versatore SteadySpout 2.0**

SteadySpout 2.0 pourer

Cod.

0533002

Cod. 0533006

0533006

STEADYSPOUT^{2.0}

THE EVOLUTION OF THE METAL POURER

Con SteadySpout avrai un versaggio sempre costante a 157BPM, l'unità di misura usata dai bartender per calibrare perfettamente la quantità di liquido nella preparazione dei cocktail.

INALTERABILE

La speciale plastica dotata di "memoria" torna alla forma originale con un passaggio in lavastoviglie.

ROBUSTO

Composto da 2 soli pezzi invece che 4.

Più solido e più resistente all'usura.

Maggiore durata nel tempo rispetto ai diretti concorrenti.

PRECISO

Velocità d'uscita del liquido garantita dalla presa d'aria. Nessuna goccia sia all'inizio che alla fine del versaggio. Ideale per la tecnica del jumping.

UNIVERSALE

Disegno e materiale delle lamelle offrono massima presa e inserimento/disinserimento facile e veloce. Il doppio modulo di diametro lo rende adatto a bottiglie con collo da Ø18 a Ø21,5 mm.

BREVETTATO

Concepito, studiato e interamente progettato dall'ufficio tecnico di PIAZZA. 100% Made in Italy.

CARATTERISTICHE TECNICHE

- Cannuccia in acciaio inox 18/10 AISI 304 con lavorazione al laser
- Diametro, rastrematura e inclinazione della cannuccia perfettamente calibrati sia all'interno che all'esterno
- Lavabile in lavastoviglie

TECHNICAL SPECIFICATIONS

- Reed in AISI 304 18/10 laser processed stainless steel
- Perfectly calibrated diameter, tapering and inclination of the reed, both inside and outside
- Dishwasher friendly

With SteadySpout, the rate of pouring is always constant at 157BPM, the unit of measurement used by bartenders to perfectly calibrate the quantity of liquid in the preparation of cocktails.

NEVER CHANGES

Special plastic with "memory" returns to the original shape simply by putting it through the dishwasher.

STURDY

Composed of only 2 pieces rather than 4.

Sturdier and more resistant to wear and tear.

Longer duration compared to the other competitors.

ACCURATE

Pouring speed of the liquid guaranteed by the air intake. No spills either at the start or end of the pouring.

Perfect for the jumping technique.

UNIVERSAL

Design and material of the reed valves offer maximum grip and an easy and fast plugging/unplugging.

The double diameter module makes it suitable for bottles with necks of diameters from Ø18 to Ø21.5 mm.

PATENTED

Conceived, developed and entirely designed by PIAZZA's technical office. Entirely manufactured in Italy



FEEL THE BEAT
MIX THE DRINKS



SCOPRI COME
LO PRODUCIAMO
DISCOVER HOW
WE MANUFACTURE IT



Riga limone

Lemon grater

Cod.
163400

L cm
14



Decora limone

Lemon decorator

Cod.
163500

L cm
14,5



Sbuccia arancia

Orange peeler

Cod.
163700

L cm
14,5



Scavino 2 coppe

Melon baller-double

Cod.
164100

L cm
16,5



Scavino 1 coppa

Melon baller

Cod.
164200

L cm
13



Set decorazione cocktail - 7 pezzi

Cocktail decoration set
7 pieces

Cod.
8151-9100G7001



COLTELLO
KNIFE



SBUCCIA ARANCIA
ORANGE PEELER



SCAVINO MELONE
MELON BALLER



COLTELLO PER PELARE
PEELING KNIFE



LEVATORE SOLO
APPLE CORER



RIGA LIMONE
LEMON GRATER



DECORA LIMONE
LEMON DECORATOR



Cucchiaino per bibita

Beverage spoon

Cod.
310207

L cm T mm Box
20 3 12



Cucchiaino per bibita

Beverage spoon

Cod.
321900

L cm Box
20 6





Vassoio rettangolare per bar in acciaio

Rectangular steel bar tray

Cod.	L x W cm
360025	25 x 19,5
360029	29 x 22
360034	34 x 27
360040	40 x 32
360046	46 x 35
360052	52 x 38
360060	60 x 45



Vassoio rettangolare per bar in acciaio con maniglie

Rectangular steel bar tray with handles

Cod.	L x W cm
360240	40 x 32
360246	46 x 35
360252	52 x 38
360260	60 x 45



Vassoio ovale per bar in acciaio

Oval steel bar tray

Cod.	L x W cm
360419	19 x 14
360423	23 x 18
360426	26 x 20



Vassoio rettangolare laminato antiscivolo

Rectangular laminated tray with non slip treatment

Cod.	L x W cm	Box
361000	37 x 53 EN	12
361100	32,5 x 53 GN 1/1	12
361200	36 x 46	12
361300	32 x 44	12
361400	33 x 43	12
361500	24,5 x 34	12
361600	28 x 20	12



Vassoio rettangolare laminato

Rectangular laminated tray

Cod.	L x W cm	Box
361001	37 x 53 EN	12
361101	32,5 x 53 GN 1/1	12
361201	36 x 46	12
361501	24,5 x 34	12



Vassoio trapezoidale laminato antiscivolo

Trapezoidal laminated tray with non slip treatment

Cod.	L x W cm	Box
362500	36 x 52	12



Vassoio trapezoidale laminato

Trapezoidal laminated tray

Cod.	L x W cm	Box
362501	36 x 52	12



Vassoio trapezoidale laminato antiscivolo

Trapezoidal laminat. tray with non slip treatment

Cod.	L x W cm	Box
362600	33 x 47	12





Vassoio ovale laminato antiscivolo

Oval laminated tray with non slip treatment	Cod.	L x W cm	Box
	363000	27 x 38	12
	363100	20 x 26,5	12



Vassoio rettangolare Rubberform antiscivolo

Rectangular Rubberform tray with non slip treatment	Cod.	L x W cm	Box
	366001	37 x 53 EN	12
	366101	32,5 x 53 GN 1/1	12
	366201	36 x 46	12
	366301	33 x 43	12
	366401	20 x 28	12
	366501	26,5 x 32,5 GN 1/2	12



Vassoio rotondo laminato antiscivolo

Round laminated tray with non slip treatment	Cod.	Ø cm	Box
	363500	43	12
	363600	38	12
	363700	32	12



Vassoio ovale Rubberform antiscivolo

Oval Rubberform tray with non slip treatment	Cod.	L x W cm	Box
	367001	21 x 29	12
	367101	20 x 26,5	12
	367301	44 x 58	12



Vassoio rettangolare KAU Polyform antiscivolo

Rectangular KAU Polyform tray with non slip treatment	Cod.	L x W cm	Box
	364000	37 x 53 EN	12
	364100	32,5 x 53 GN 1/1	12



Vassoio rotondo Rubberform antiscivolo

Round Rubberform tray with non slip treatment	Cod.	Ø cm	Box
	367501	43	12
	367601	38	12
	367701	32	12



Vassoio rotondo KAU Polyform antiscivolo

Round KAU Polyform tray with non slip treatment	Cod.	Ø cm	Box
	365500	36	12



Vassoio rettangolare in poliestere rinforzato

Oval reinforced tray in polyester	Cod.	L x W cm	Box
	368000	37 x 53 EN	12
	368300	26,5 x 32,5 GN 1/2	12



Vassoio ovale in poliestere rinforzato

Oval reinforced tray in polyester	Cod.	L x W cm	Box
	368500	21 x 29	12



**Lattiera**

Milk jug

Cod.	ml
460503	250
460504	350
460506	500
460509	750
460512	1000

**Spargicacao**

Cocoa sprinkler

Cod.	H cm
470500	9

**Mestolino per ciliegie**

Cherry ladle

Cod.	Ø cm	L cm
430900	4	23

**Mestolino per ciliegie con fori**

Cherry ladle with holes

Cod.	Ø cm	L cm
431000	4	23

**Mestolino per ciliegie manico lungo**

Cherry ladle

Cod.	Ø cm	L cm
431100	4	28

**Mestolino per ciliegie**

Cherry ladle

Cod.	Ø cm	L cm
431200	4	21,5

**Mestolino per ciliegie con fori**

Cherry ladle with holes

Cod.	Ø cm	L cm
431300	4	21,5

**Spremiagrumi**

Citrus juicer

Cod.	Ø cm	cl
470700	13	50





Jigger

Double jigger

Cod.	ml
470812	scaled 20-30-50 30 x 60
470813	30 x 90
470823	60 x 90



Cucchiaino per cocktail

Cocktail spoon

Cod.	L cm
471200	15



Colino per cocktail

Cocktail strainer

Cod.	L cm
470900	16



Cucchiaino per bibita triangolare

Triangular long drink spoon

Cod.	L cm
4715246	24



Agitatore

Stirring spoon

Cod.	L cm
471000	24



Portacucchiaini

Moka spoon holder

Cod.	Ø cm	H cm
472100	7	8



Cucchiaino per ghiaccio

Ice spoon

Cod.	L cm
471100	24



Vaschetta lavaggio dosatori gelato

Rinsing basin

Cod.	Ø cm	H cm
472200	8,5	11





Levacapsule

Bottle-opener

Cod. L cm
472700 14



Spremilimone

Lemon slice squeezer

Cod. **4728002**



Spremilimone

Lemon slice squeezer

Cod. **4729002**

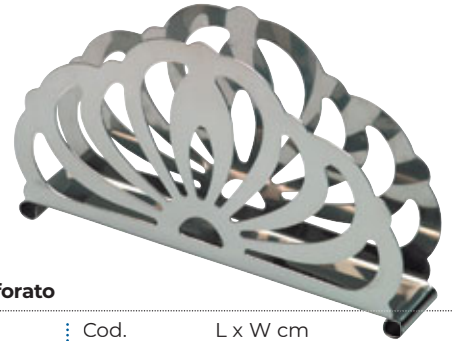

Portatovaglioli traforato

Napkin-holder

Cod. L x W cm
473000 13,5 x 7

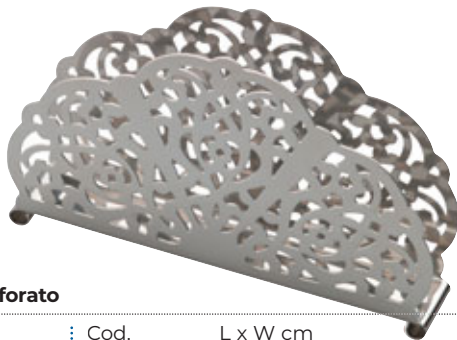

Portatovaglioli traforato

Napkin-holder

Cod. L x W cm
473100 13,5 x 7



Portatovaglioli con base teak

Napkin stand

Cod. L x W cm
473200 14 x 8



Cuocithé a cucchiaino

Spoon tea infuser

Cod. L cm
473300 15



Cuocithé a campana

Bell tea boiler

Cod. **473400**



Sottobicchiere

Coaster

Cod. Ø cm
474209 9
474210 10



Cod. **474213**



Sottobottiglia

Coaster

Cod. Ø cm
474213 13







Boston shaker in acciaio

Stainless steel boston shaker	Cod.	Col.	ml
	474690	●	900
	474700	●	900
	474703	●	900



Boston shaker in acciaio colorato

Coloured stainless steel boston shaker	Cod.	Col.	ml
	474750	●	900
	474753	●	900



Boston shaker in acciaio

Stainless steel boston shaker	Cod.	ml
	474850	500



Boston shaker in acciaio a due pezzi

2-parts stainless steel boston shaker	Cod.
	474890





Colino per cocktail

Cocktail strainer Cod. L cm
470900 16



Bicchiere vetro per boston shaker

Glass for boston shaker Cod. ml Box
474900 474 6



Colino per cocktail

Cocktail strainer Cod. ml
475600



Bicchiere vetro per boston shaker temperato

Tempered glass for boston shaker Cod. ml Box
474901 414 6



Colino per cocktail in acciaio con manico vuoto

Steel cocktail strainer with hollow handle Cod. ml
475601



Bicchiere vetro per boston shaker graduato

Scaled glass for boston shaker Cod. ml Box
474902 474 6



Colino per cocktail in acciaio color grafite

Black steel cocktail strainer Cod. ml
475605



Bicchiere vetro "beverage" per boston shaker

"Beverage" glass for boston shaker Cod. ml Box
474904 414 6



**Japmixing glass
con beccuccio**

Japmixing glass with lip Cod. ml
474906 650

**Mixing glass double wall
in acciaio con beccuccio**

Stainless steel double wall mixing glass with lip Cod. ml
474910 535

**Bicchieri Juice
per cocktail**

Juice cocktail glass Cod. ml Box
474915 421 12

**Bicchieri High Ball
per cocktail**

High Ball cocktail glasses Cod. ml Box
474916 361 12
474920 361 12

**Bicchieri Rocks,
Shooter e Shot Rocks
per cocktail**

Rocks, Shooter and Shot Rocks cocktail glasses Cod. ml Box
474917 269 12
474918 137 12
474919 37 12

Shaker a 2 pezzi lucido

2-parts polished shaker Cod. ml
475055 550





Shaker a 2 pezzi in acciaio

2-parts steel shaker

Cod. **475060** ml 600



Shaker a 2 pezzi in acciaio ramato

2-parts copper plated shaker

Cod. **475160** ml 600



Shaker a 2 pezzi satinato

2-parts brushed shaker

Cod. **477080** ml 800



Shaker a 3 pezzi in acciaio

3-parts steel shaker

Cod. **475225** ml 250
475250 ml 500
475275 ml 750



Shaker a 3 pezzi lucido

3-parts polished shaker

Cod. **475175** ml 750



Shaker a 2 pezzi in ottone

2-parts brass shaker

Cod. **475440** ml 400



Shaker a 2 pezzi in rame

2-parts copper shaker

Cod. **477260** ml 600



Shaker a 2 pezzi in acciaio color grafite

2-parts steel black shaker

Cod. **477160** ml 600





Jigger in acciaio Japan style

Stainless steel jigger Japan style

Cod.	ml	Col.
475542	25 x 50	●
475544	25 x 50	●



Jigger Japan style

Jigger Japan style

Cod.	ml	Col.
475546	30 x 50	●



Jigger in acciaio Japan style

Stainless steel jigger Japan style

Cod.	ml
475535	20 x 40
475543	25 x 50
475550	15 x 30
475555	30 x 60
475560	30 x 45



Jigger in acciaio slim

Stainless steel jigger slim

Cod.	ml
475570	30 x 45
475575	25 x 50
475580	30 x 60



Jigger in acciaio

Steel double jigger

Cod.	ozs
475545	3/4 x 1,1/2



Jigger in acciaio

Stainless steel jigger

Cod.	ml	Col.
475590	30 x 60	●
475591	30 x 60	●
475592	30 x 60	●





Jigger in acciaio
Mixing Tin style

Stainless steel jigger
Mixing Tin style

Cod. 475500 ml 75



Jigger in acciaio

Stainless steel jigger

Cod. 475565 ml 75



Jigger in plastica

Plastic jigger

Cod. 475548 ml 20 x 40
475549 ml 10 x 20



Jigger

Double jigger

Cod. 470812 scaled 20-30-50 ozs 1-2
470813 1-3
470823 2-3



Set 8 pezzi Bartending Essentials

Bartending Essential
Pack 8 pcs.

Cod. 665500



Set 5 pezzi Bartending Black Edition

Bartending Black
Edition Pack 5 pcs.

Cod. 665600



- 0533002 TAPPO VERSATORE STEADYSPOUT STEADYSPOUT POURER (2 PZ.)
- 470900 COLINO COCKTAIL COCKTAIL STRAINER
- 474690 BOSTON SHAKER IN ACCIAIO STAINLESS STEEL BOSTON SHAKER
- 475545 JIGGER IN ACCIAIO STEEL DOUBLE JIGGER 3/4 x 1.1/2 OZS
- 475828 CUCCHIAIO MISCELAT. CON PESTELLO MIXING SPOON WITH STUD
- 510200 PESTELLO RIGATO IN POLIPROPILENE POLYPROP. RIBBED PESTLE
- TUMBLER ALTO IN HIGH TUMBLER

- 053212 TAPPO VERSATORE POURER
- 475542 JIGGER IN ACCIAIO STEEL DOUBLE JIGGER 25/50 ML
- 475605 COLINO COCKTAIL COCKTAIL STRAINER
- 475832 CUCCHIAIO MISCEL. CON FORCHETTA MIXING SPOON WITH FORK
- 477160 COCKTAIL SHAKER IN ACCIAIO STEEL COCKTAIL SHAKER 600 ML



Sessola in plastica

Plastic ice scoop	Cod.	ml	Box
	506800	180	6
	506801	360	6
	506802	720	6



Pestello in polipropilene liscio

Smooth polypropylene pestle	Cod.	L cm	Col.	Box
	510000	21	●	6
	510002	21	○	6



Cod. 510000



Pestello in polipropilene rigato

Ribbed polypropylene pestle	Cod.	L cm	Col.	Box
	510200	21,5	●	6
	510202	21,5	○	6



Cod. 510200



Pestello in polipropilene nero

Black polypropylene pestle	Cod.	L cm
	510300	21,5



NEW

Pestello in acacia

Pestle	Cod.	L cm
	503300	19
	503301	25



Sessola in polipropilene

Polypropylene ice scoop	Cod.	ml	Box
	506811	360	6



Rompighiaccio manuale in plastica finitura cromo

Chrome-finished plastic manual ice-breaker	Cod.
	503900



Rompighiaccio a 6 punte

6-point ice-breaker	Cod.
	504000

- **Rompighiaccio professionale ideato per la preparazione di Caipirinhas, Mojitos e frozen vari, idoneo inoltre per guarnire piatti di pesce fresco**
Professional ice-breaker designed for preparing Caipirinhas, Mojitos and various frozen drinks, also for garnishing fresh fish dishes
- **Robusto e veloce, consente di preparare ghiaccio spezzato con una produttività di 2 kg al minuto**
Fast and strong, it lets you prepare chopped ice at a rate of 2 kg a minute
- **Corpo in lega leggera e contenitore in acciaio inox con motore ventilato con potenza di 150 watt**
Light alloy body and stainless steel bucket with 150 watt fan motor
- **Approvato CE**
CE approved



Rompighiaccio verticale in acciaio

Steel vertical ice-breaker	Cod.	Volt
	550700	220





Cucchiaino miscelatore in acciaio con tappo rosso

Steel mixing spoon	Cod.	L cm	Box
	475725	25	12
	475728	28	12

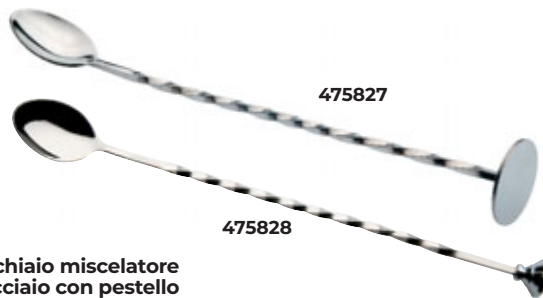

Cucchiaino miscelatore in acciaio con pestello

Steel mixing spoon with stud	Cod.	L cm	Box
	475827	27	12
	475828	28	12



Cucchiaino miscelatore in acciaio a goccia

Drop steel mixing spoon	Cod.	L cm	Box
	475800	25	6
	475805	30	6
	475810	40	6
	475815	50	6



Cucchiaino miscelatore in acciaio con forchetta

Steel mixing spoon with fork	Cod.	L cm	Col.	Box
	475830	30	●	6
	475831	30	●	6
	475832	30	●	6



Cucchiaino miscelatore in acciaio coppa ovale

Oval cup steel mixing spoon	Cod.	L cm	Box
	475930	30	12

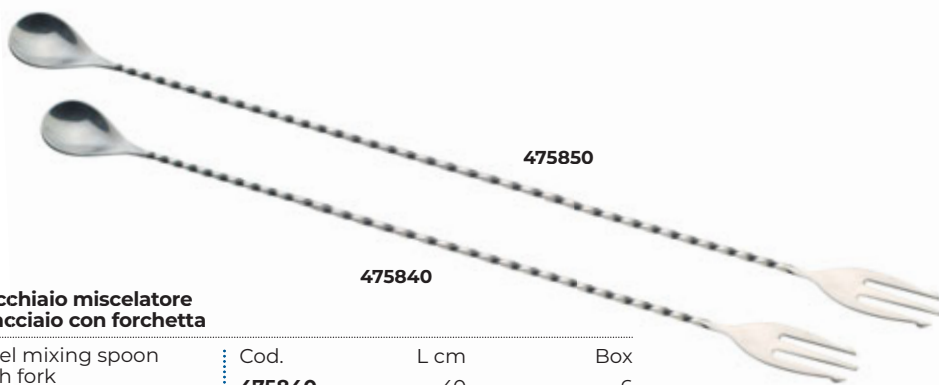

Cucchiaino miscelatore in acciaio con forchetta

Steel mixing spoon with fork	Cod.	L cm	Box
	475840	40	6
	475850	50	6





Julep mug in acciaio inox

Stainless steel julep mug Cod. ml
4781482 380



Moscow Mule mug bombata in acciaio dorato e martellato

Golden plated hammered Moscow Mule mug Cod. ml
478302 500



Moscow Mule mug bombata in acciaio ramato e martellato

Copper plated hammered Moscow Mule mug Cod. ml
4783002 470



Moscow Mule mug bombata in acciaio ramato

Copper plated Moscow Mule mug Cod. ml
4783052 470



Mug in acciaio ramato

Copper plated mug Cod. ml
4783152 470



Beer mug in acciaio ramato, effetto anticato

Copper plated beer mug antique Cod. ml
4783252 500



Beer mug in acciaio ramato, effetto anticato

Copper plated beer mug antique Cod. ml
4783302 500
4783352 400





**Mug ananas
in acciaio ramato**

Copper plated
pineapple mug

Cod. **478321** ml 550



**Mug zucca
in acciaio ramato**

St. steel copper plated
gourd mug

Cod. **478351** ml 350



Mug in acciaio

Stainless steel mug

Cod. **478350** ml 700



**Mug zucca
in acciaio ramato**

St. steel copper plated
pumpkin mug

Cod. **478352** ml 650



478340

478342

**Mug pera
in acciaio**

Stainless steel
pear mug

Cod.	ml	Col.
478340	425	●
478342	425	●



**Wine glass in acciaio
color grafite**

Black stainless steel
wine glass

Cod. **4783452** ml 550







Dash bottle "Old fashioned"

Dash bottle "Old fashioned" Cod. ml
479101 100
479190 Tappo versatore/Pourer for dash bottle



TAPPO VERSATORE NON INCLUSO
 POURER NOT INCLUDED



Dash bottle

Dash bottle Cod. ml
479110 100
479190 Tappo versatore/Pourer for dash bottle



TAPPO VERSATORE NON INCLUSO
 POURER NOT INCLUDED



Vaporizzatore cocktail in vetro "Old fashioned"

Cocktail atomizer "Old fashioned" Cod. ml
479121 100



IMBUTO DI RIEMPIMENTO INCLUSO NELLA CONFEZIONE
 FUNNEL INCLUDED IN THE PACKAGE



Vaporizzatore cocktail cromato

Chromed cocktail atomizer Cod. ml
479130 65



IMBUTO DI RIEMPIMENTO INCLUSO NELLA CONFEZIONE
 FUNNEL INCLUDED IN THE PACKAGE



Kit 4 vaporizzatori cocktail in vetro 2 cilindrici + 2 quadrati

Pack 4 cocktail atomizers Cod. ml.
 2 cylindrical + 2 square **479150** 33



IMBUTO DI RIEMPIMENTO INCLUSO NELLA CONFEZIONE
 FUNNEL INCLUDED IN THE PACKAGE



Spremilimone nero

Lemon squeezer black Cod. **476402**

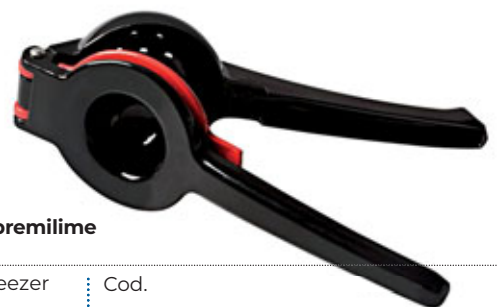

Spremilimone/spremilime nero e rosso

Lemon/lime squeezer black and red Cod. **476412**





Coltello per agrumi

Citrus fruit knife	Cod.	L cm	Box
	476600	21	12



Apribottiglie piatto in acciaio

Flat steel bottle-opener	Cod.	L cm	Box
	476800	18	12



Apribottiglie professionale in acciaio satinato

Professional satin-finish steel bottle-opener	Cod.
	476900



Pinza apribottiglie in acciaio

Steel champagne opener	Cod.
	477300



Apribottiglie da muro in acciaio

Steel wall-mounted bottle-opener	Cod.	Box
	477400	12



Apribottiglie da muro

Wall-mounted bottle-opener	Cod.
	477500



Spirale di ricambio per apribottiglie muro e tavolo

Spare screw for table/wall corkscrews	Cod.	Box
	477550	12



Sessola in acciaio

Steel all purpose scoop	Cod.	L cm	Box
	477900	24	12



Secchiello ghiaccio in acciaio

Steel ice bucket	Cod.	Ø cm	H cm
	478014	14	16





Secchiello vino in acciaio

Steel wine bucket

Cod.	Ø cm	H cm
478421	21	21



Secchiello vino in acciaio

Steel wine bucket

Cod.	Ø cm	H cm
478624	24	26

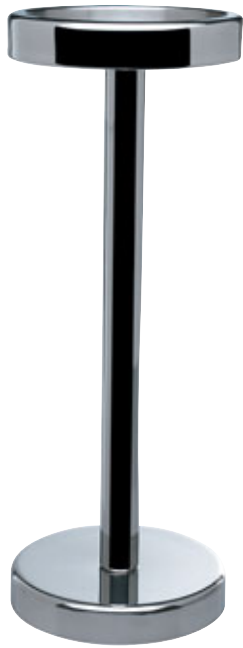

Colonna per secchiello in acciaio

Stand for steel bucket

Cod.	Ø cm	H cm
478525	25	65



PER FOR
478421

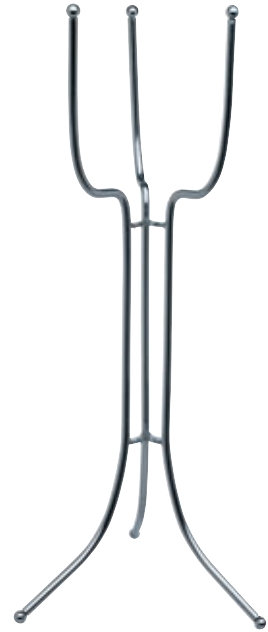

Colonna a filo in acciaio per secchiello vino

Steel wire bucket stand

Cod.	Ø cm	H cm
478760	24	60



PER FOR
478624



Spumantiera in acciaio

Steel champagne bowl

Cod.	Ø cm
479400	40





Portatovaglioli in acciaio

Napkin holder	Cod.	H cm	Box
	479600	18	6
	479601	10	6



Portacondimenti plastica con 3 contenitori (L)

Black plastic cruet with 3 containers (L)	Cod.	L x W cm	H cm
	502000	49 x 15	9



Portacondimenti in acciaio con 3 contenitori

Steel cruet with 3 containers	Cod.	L x W cm	H cm
	479803	45 x 15	9



Portacondimenti plastica con 4 contenitori (M)

Black plastic cruet with 4 containers (M)	Cod.	L x W cm	H cm
	502100	49 x 15	9



Portacondimenti in acciaio con 4 contenitori

Steel cruet with 4 containers	Cod.	L x W cm	H cm
	479804	30 x 14	9



Portacondimenti plastica con 6 contenitori (S)

Black plastic cruet with 6 containers (S)	Cod.	L x W cm	H cm
	502300	49 x 15	9



Portacondimenti in acciaio con 6 contenitori

Steel cruet with 6 containers	Cod.	L x W cm	H cm
	479806	45 x 15	9



Contenitore sostitutivo in plastica

Spare plastic container	Cod.	L x W cm	H cm	Box
	502400	7 x 14 (S)	7	12
	502401	14 x 14 (L)	7	12
	502402	11 x 14 (M)	7	12





Speed racks in acciaio

Steel speed racks

Cod.	L cm
479900	56
479901	82
479902	107

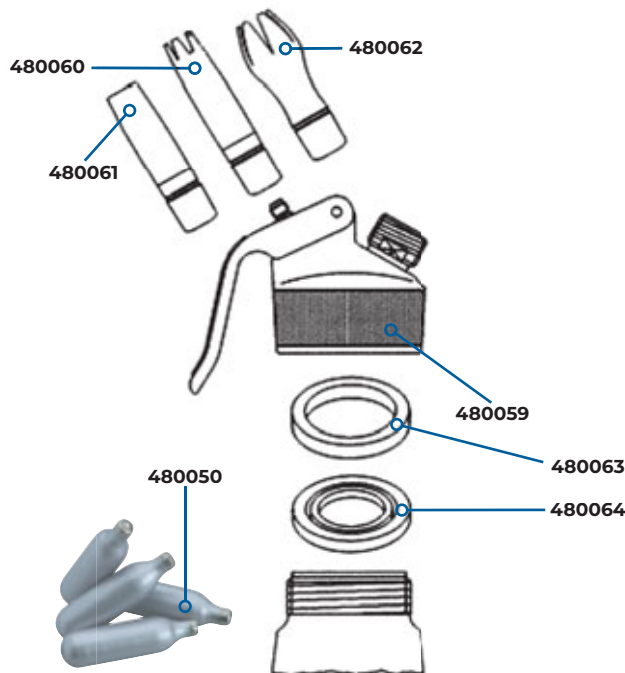

Ricambi per sifone panna montata

Spare parts for whipped cream syphon

Cod.

- 480050** Ricarica/Refill (10 pz/pcs)
- 480059** Testata completa in metallo/Head complete metal
- 480060** Decorat. di ricambio rosso/Round shape nozzle red
- 480061** Decorat. di ricambio piatto/Plain shape nozzle
- 480062** Decorat. di ricambio tulipano/Tulip shape nozzle
- 480063** Guarnizione per testata rossa/Head gasket red
- 480064** Guarnizione per testata grigia/Head gasket grey



Sifone termico per panna montata

Thermos syphon for whipped cream

Cod.	Lt
480005	0,5



Raccogliatrice in alluminio

Aluminum crumb collector

Cod.	Box
490108	24



Sifone per panna montata

Whipped cream syphon

Cod.	Lt
480105	0,5
480110	1



Barra ordinazioni in alluminio

Aluminum order rack

Cod.	L cm
490000	30
490001	45
490002	61
490003	91
490004	122





Versus completo da 0,5 lt

Complete versus 0.5 lt	Cod.	Col.	cl	Box
	500000		50	12

Versus riserva da 0,5 lt
Colori assortiti



Spare versus 0.5 lt (various colours)	Cod.	Col.	cl	Box
	500100		50	12

versus

Design by Michele Capuani

Una gamma completa di versatori, risultato di un progetto studiato fin nei minimi particolari, in grado di offrire ai professionisti del settore Bar prestazioni ineguagliabili. Materiali di prim'ordine, caratteristiche tecniche all'avanguardia, forme progettate ergonomicamente, dettagli costruttivi analizzati fin nei minimi particolari, tutto è stato studiato per garantire non solo prestazioni "al top" in ogni situazione, ma anche per offrire il massimo in termini di comodità, praticità, facilità d'uso, igienicità.

A complete range of pourers, the result of a detailed project, capable of offering Bar professionals unmatched performance. Top grade materials, advanced technology, ergonomic design, construction details that have been carefully studied right down to the smallest details: all aimed at guaranteeing not just "top" performance in all situations, but also max comfort, practicality, ease of use and hygiene.



Versus completo da 1 lt

Complete versus 1 lt	Cod.	Col.	cl	Box
	500200		100	12
	500201		100	12
	500203		100	12
	500204		100	12
	500206		100	12

Versus riserva da 1 lt
Colori assortiti



Spare versus 1 lt (various colours)	Cod.	Col.	cl	Box
	500300		100	12



Chiodibeccuccio a tenuta per garantire la massima igienicità nell'utilizzo.

Spout seal to guarantee max hygiene during use.

Beccuccio versatore in colori assortiti, studiato per offrire un flusso del liquido costante ed omogeneo. Il suo ancoraggio al collo di versus avviene attraverso un giro completo di filettatura per una tenuta ottimale in ogni condizione d'uso.

Pouring spout in various colours, designed to get a constant, even flow. Fixed to the neck of the versus via 360° threading for excellent tightness in all conditions.

Il collo è stato disegnato secondo principi ergonomici per consentire una perfetta impugnatura e rendere l'operazione di versatura pratica e veloce in tutte le condizioni di utilizzo. La sua particolare filettatura (a doppio giro) garantisce una tenuta totale, rendendolo nel contempo universale, può essere infatti montato non solo su tutte le riserve versus ma anche su quelle delle altre marche più diffuse.

The ergonomic design of the neck makes for a perfect grip and practical, fast operation in all conditions. The special threading (double turn) guarantees perfect tightness and an universal fitting not only to the versus juice containers but to other leading brands, too.

La riserva, disponibile in varie capacità, con la sua comoda scala graduata consente l'immediata visione della quantità di prodotto presente all'interno.

The juice containers, available in various sizes, have a useful graduated scale and you can immediately see how much liquid they contain.

La base zigrinata della riserva permette il perfetto ancoraggio del suo coperchio quando questo viene rimosso per inserire il collo.

The knurled base of the juice containers allows a perfect fitting of its cover once removed to assemble the neck.



Versus completo da 2 lt

Complete versus 2 lt	Cod.	Col.	cl	Box
	500400		200	12
	500401		200	12
	500403		200	12
	500404		200	12
	500406		200	12



**Versus riserva da 2 l.
Colori assortiti**

Spare versus 2 lt (various colours)	Cod.	Col.	cl	Box
	500500		200	12



Versus con beccuccio versatore

Versus with pouring spout	Cod.	Col.	cl	Box
	500800		100	12



Speed bottle completo da 1 litro

Speed bottle 1 litro	Cod.	Col.	cl	Box
	500900		100	12
	500901		100	12
	500903		100	12
	500904		100	12
	500906		100	12



Beccuccio versatore

Pouring spout	Cod.	Col.	Box
	500811		48
	500813		48
	500814		48
	500816		48



Beccuccio versatore "Versus"

"Versus" pouring spout	Cod.	Col.	Box
	50100112		4
	50100312		4
	50100412		4
	50100612		4



Versus con beccuccio versatore

Versus with pouring spout	Cod.	cl	Box
	500890	100	12



Coperchio chiusura "Versus"

"Versus" lid	Cod.	Col.	Box
	5011016		8
	5011036		8
	5011046		8
	5011066		8



Bordatore di bicchieri nero a 2 unità in plastica

2-tier black plastic glass rimmer

Cod. **502600**



Bordatore di bicchieri nero a 3 unità in plastica

3-tier black plastic glass rimmer

Cod. **502700**



Portaoggetti da bar in plastica

Plastic bar organizer

Cod. **502500**

L x W cm H cm
24 x 14 10



Spugna sostitutiva per bordatori

Spare sponge for glass rimmer

Cod. **502800**





Tappetino da bar in plastica

Plastic bar mat	Cod.	L x W cm	Col.
	502900	7,5 x 58,5	●
	502903	8,5 x 60	●

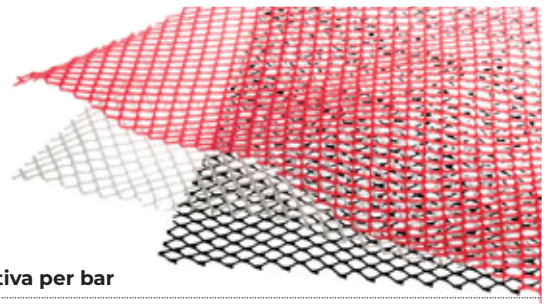

Rete protettiva per bar

Protection mesh for bar	Cod.	L x W cm	Col.
	503400	61 x 610	●
	503401	61 x 610	●
	503402	61 x 610	○



Tappetino da servizio nero in plastica

Black plastic bar mat	Cod.	L x W cm
	503000	30,5 x 46



Tappetino scolabicchieri

Dri-dek interlocking glass mat	Cod.	L x W cm	Col.
	503410	33 x 33	●
	503411	33 x 33	○



Tagliere in polietilene nero

Black polyethylene cutting board	Cod.	L x W cm	H cm
	503200	30 x 50	2

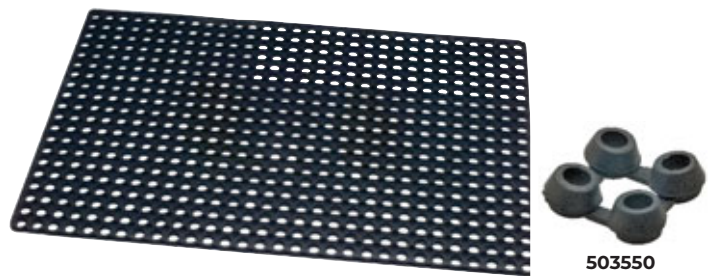

Tappeto antiscivolo

Non slip matting	Cod.	L x W cm
	503500	91 x 91
	503501	80 x 120
	503502	100 x 150
	503550	Ganci fissaggio/Carpet hooks (5 pz/pcs)

NEW



Tagliere in polietilene bianco con canalina

White polyethylene cutting board with canal	Cod.	L x W cm	H cm
	503205	12 x 22	1



503700

503701

Flair bottle professionale

Professional flair bottle

Cod.	cl
503700	75
503701	75



503703

503705

Flair bottle

Flair bottle

Cod.	cl	Col.
503703	75	○
503705	75	○



Flair bottle

Flair bottle

Cod.	cl	Col.
503710	75	○
503712	75	○
503713	75	●
503716	75	●



Portacenere in acciaio rotondo

Round steel ashtray

Cod.	Ø cm	Box
481113	13	12



Posacenere in alluminio

Aluminum ashtray

Cod.	Ø cm	Col.
490408	10	○



Posacenere rotondo in plastica

Round plastic ashtray

Cod.	Ø cm	Col.	Box
504100	10	●	6
504101	10	●	6



Posacenere rotondo in plastica

Round plastic ashtray

Cod.	Ø cm	Col.	Box
504200	14	●	6
504201	14	●	6





Dispenser in polietilene

Polyethylene dispenser	Cod.	ml	ozs	Col.	Box
	5045016	236	8	●	6
	5045026	236	8	○	6
	5045036	236	8	●	6
	5046016	354	12	●	6
	5046026	354	12	○	6
	5046036	354	12	●	6
	5047016	708	24	●	6
	5047026	708	24	○	6
	5047036	708	24	●	6



Bicchieri in plastica trasparente

Clear plastic glass	Cod.	ml	Box
	505700	360	50
	505701	400	50
	505702	290	80
	505705	40	60
	505750	400	50



Bicchieri in plastica

Plastic glass	Cod.	ml	ozs	Box
	504902	236	8	72



Bicchieri in polipropilene ghiaccio

Iced polypropylene glass	Cod.	ml	Box
	505800	360	50
	505801	400	50



Bicchieri in plastica zigrinato trasparente

Clear knurled plastic glass	Cod.	ml	ozs	Box
	505300	148	5	72
	505301	237	8	72
	505302	296	10	72
	505303	355	12	72



Caraffa in plastica trasparente

Clear plastic carafe	Cod.	Lt	Box
	506200	0,95	6
	506201	1,4	6
	506202	1,8	6





Portazucchero trasparente in plastica

Clear plastic sugar bowl Cod. **5074022** Box 6



Cannuccia diritta in acciaio inox

Straight stainless steel straw Cod. **517021** L cm 13



CON SCOVOLINO WITH STRAW CLEANER

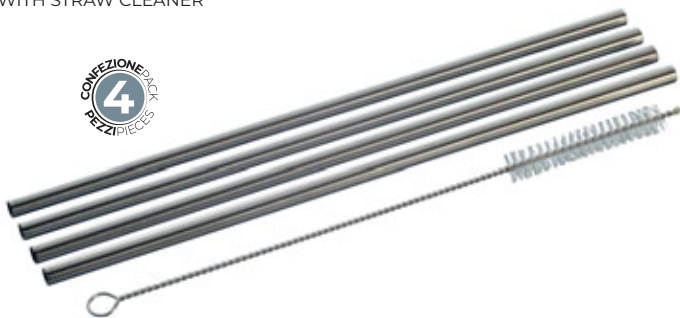

Cannuccia diritta in acciaio inox

Straight stainless steel straw Cod. **517121** L cm 21,5



CON SCOVOLINO WITH STRAW CLEANER

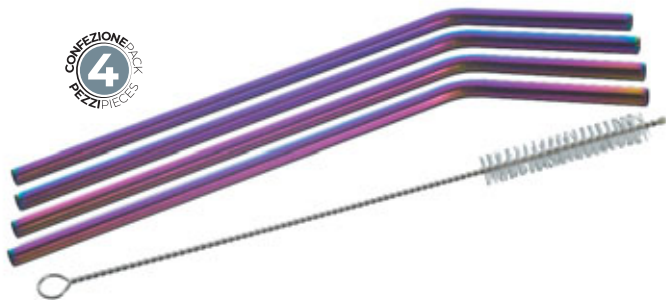

Cannuccia piegata in acciaio inox colorato

Bended coloured stainless steel straw Cod. **517420** L cm 21,5



CON SCOVOLINO WITH STRAW CLEANER



Portazucchero in plastica

Plastic sugar bowl	Cod.	Col.	Box
	5075002	●	6
	5075012	●	6
	5075022	○	6
	5075032	●	6
	5075042	●	6

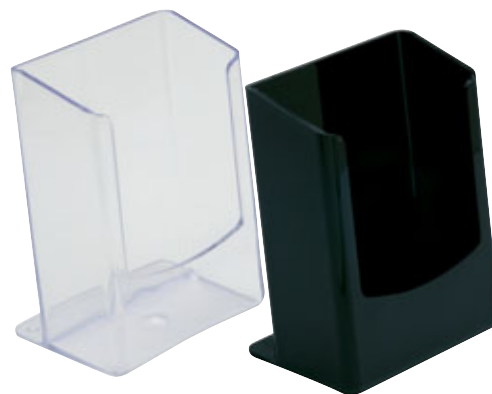

Portatovaglioli in plastica

Plastic serviette holder	Cod.	Col.	Box
	5079002	●	6
	5079022	○	6



Poggiavassoio in legno color nero con gommini antiscivolo

Black wood tray rest with non slip rubber pad	Cod.	L x W cm	H cm
	506900	43 x 43	83





6
CONFEZIONE
PEZZI/PIECES

Cestino in polipropilene ovale

Oval polypropylene basket	Cod.	L x W cm	Col.	Box
	5070016	24 x 15	●	6
	5070036	24 x 15	●	6
	5070046	24 x 15	●	6
	5070056	24 x 15	●	6
	5070066	24 x 15	●	6



6
CONFEZIONE
PEZZI/PIECES

Cestino in polipropilene ovale

Oval polypropylene basket	Cod.	L x W cm	Col.	Box
	5071016	28 x 18	●	6
	5071036	28 x 18	●	6
	5071046	28 x 18	●	6



6
CONFEZIONE
PEZZI/PIECES

Cestino in polipropilene color vimini naturale rotondo

Round polypropylene natural wicker basket	Cod.	Ø cm	H cm
	508518	18	5
	508521	21	6



NON ADATTO ALLA LAVASTOVIGLIE
NOT DISHWASHER SAFE



6
CONFEZIONE
PEZZI/PIECES

Cestino in polipropilene color vimini naturale rettangolare

Rectangular polyprop. natural wicker basket	Cod.	L x W cm	H cm
	508623	23 x 15	6



NON ADATTO ALLA LAVASTOVIGLIE
NOT DISHWASHER SAFE



6
CONFEZIONE
PEZZI/PIECES

Cestino in polipropilene color vimini naturale ovale

Oval polypropylene natural wicker basket	Cod.	L x W cm	H cm
	508718	18 x 13	5
	508723	23 x 16	6
	508725	25 x 17	8



NON ADATTO ALLA LAVASTOVIGLIE
NOT DISHWASHER SAFE

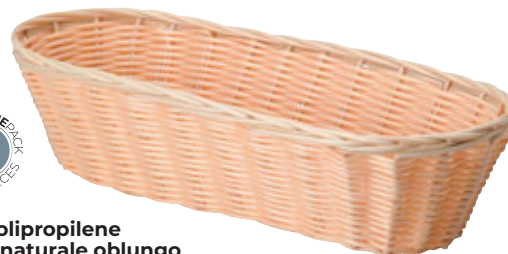

6
CONFEZIONE
PEZZI/PIECES

Cestino in polipropilene color vimini naturale oblungo

Oblong polypropylene natural wicker basket	Cod.	L x W cm	H cm
	508823	23 x 9	5
	508828	28 x 15	8
	508833	33 x 13	8



NON ADATTO ALLA LAVASTOVIGLIE
NOT DISHWASHER SAFE



6
CONFEZIONE
PEZZI/PIECES

Cestino in polipropilene intrecciato marrone rotondo

Round brown woven polypropylene basket	Cod.	Ø cm	H cm
	509529	29	8



NON ADATTO ALLA LAVASTOVIGLIE
NOT DISHWASHER SAFE



6
CONFEZIONE
PEZZI/PIECES

Cestino in polipropilene intrecciato marrone ovale

Oval brown woven polypropylene basket	Cod.	L x W cm	H cm
	509627	27,5 x 20	7



NON ADATTO ALLA LAVASTOVIGLIE
NOT DISHWASHER SAFE



BB340E

BB320E

Frullatore da bar 1 CV

1 HP commercial blender	Cod.	cl
	5610-BB320E	140
	5610-BB340E	140



- **Potente motore da 1 CV a 2 velocità con funzione Impulso**
1 HP commercial motor, 2-speed with PULSE function
- **Contenitore da 1,4 litri in copoliestere privo di BPA, lama in acciaio inox**
1.4 liter BPA-free copolyester container with industrial stainless steel blade
- **La base removibile gommata del bicchiere riduce il rumore e facilita la pulizia**
Removable rubberized jar pad dampens sound and makes cleanup easy
- **Tre Margarita da 475 ml in 12 secondi o anche meno**
Three 475 ml. (16 oz.) Margaritas in 12 seconds or less
- **Ideale per preparare da 25 a 50 drinks al giorno**
Recommended for 25-50 drinks per day
- **230 VCA, 750W**



BB320E TASTIERA ELETTRONICA
ELECTRONIC KEYPAD



BB340E TASTIERA ELETTRONICA CON TIMER
DA 99 SECONDI
ELECTRONIC KEYPAD WITH 99-SECOND COUNTDOWN TIMER

Xtreme - Frullatore ad alta potenza 3,5 CV

Xtreme - 3.5 HP blender	Cod.	cl
	5615-MX1000XTXEE	200
	5615-MX1100XTXEE	200
	5615-MX1200XTXEE	200
	5615-MX1300XTXEE	200
	5615-MX1500XTXEE	200



- **Motore da 3,5 CV di picco per carichi di lavoro intensi**
Heavy-duty 3½ peak HP motor
- **Velocità pura del motore 32.000 giri/min, 1500 watt**
32,000 RPM bare motor speed, 1500 watts
- **Base del bicchiere monopezzo removibile lavabile in lavastoviglie**
One-piece dishwasher-safe removable jar pad
- **Contenitore da 2 litri in copoliestere privo di BPA**
2 L BPA-free copolyester container
- **Disponibili contenitori in copoliestere privo di BPA da 1,4 litri e in acciaio da 1,4 e 2 litri**
1.4 L BPA-free copolyester container and 1.4 and 2 L stainless steel containers available
- **Disponibilità di involucro antirumore**
(incluso nel modello MX1500)
Optional sound enclosure (included for MX1500)
- **230 VCA, 50 Hz, 6,5 amp**
- **Disponibili anche nella versione 60 Hz**
Also available in 60 Hz



MX1300XTXEE
INVOLUCRO ANTIRUMORE
NON INCLUSO
SOUND ENCLOSURE
NOT INCLUDED
MX1500XTXEE



MX1000XTXEE
INTERRUTTORI A PALETTA
CON HI (ALTO), LO (BASSO),
E PULSE (IMPULSO)
PADDLE SWITCHES WITH
HIGH, LOW AND PULSE



MX1100XTXEE
TASTIERA ELETTRONICA
CON HI (ALTO), LO (BASSO),
PULSE (IMPULSO)
E TIMER DA 30 SECONDI
ELECTRONIC KEYPAD WITH
HIGH, LOW, PULSE
FUNCTIONS AND 30-SECOND
TIMER



MX1200XTXEE
MANOPOLA VARIATORE
DI VELOCITÀ E PULSE
(IMPULSO) CON
INTERRUTTORE A PALETTA
VARIABLE SPEED DIAL
CONTROL AND PULSE
PADDLE SWITCH



MX1300XTXEE
MX1500XTXEE
TASTIERA ELETTRONICA
PROGRAMMABILE, LCD
DISPLAY E COMANDO
PULSE PROGRAMMABLE
ELECTRONIC KEYPAD, LCD
DISPLAY AND PULSE



MX1000XTXEE

MX1100XTXEE

MX1200XTXEE



Frullatore da bar Torq 2.0 - 1,4 L

Blender Torq 2.0 - 1.4 L	Cod.	cl
	5610-TBB145E	140
	5610-TBB160E	140
	5610-TBB175E	140



- **Motore da 2 CV, a 2 velocità ad alte prestazioni**
High-performance 2HP motor, 2 speeds
- **Tre Margarita da 475 ml in 8 secondi o anche meno**
Three 475 ml. (16 oz.) Margaritas in 8 seconds or less
- **Contenitore da 1,4 litri in copoliestere privo di BPA, impilabile**
1.4 L BPA-free unbreakable copolyester container
- **Coperchio removibile in gomma alimentare, con foro per aggiungere ingredienti**
Vinyl lid with removable center cap to feed ingredients while blending
- **Resistente giunto di trasmissione in acciaio inossidabile sostituibile**
Heavy-duty stainless steel replaceable drive and jar couplings
- **230 VCA, 60 Hz, 13 amp**



TBB175E



TBB145E
COMMUTATORI
HI/LO/OFF
(ALTO/BASSO/STOP)
E PULSE (IMPULSO)
HI/LO/OFF AND PULSE
TOGGLE SWITCHES



TBB160E
TASTIERA
ELETTRONICA
CON TIMER DA 60
SECONDI
ELECTRONIC KEYPAD
WITH 60-SECOND
COUNTDOWN TIMER



TBB175E
MANOPOLA
VARIATORE
DI VELOCITÀ
1000 - 17000 GIRI/MIN
VARIABLE SPEED
CONTROL DIAL
1000 - 17000 RPM

Frullatore da 4 Litri

4 liter food blender	Cod.	cl
	5610-CB15VE	400



- **Motore da 3,75 CV per carichi di lavoro intensi**
Heavy-duty 3¾ HP motor
- **I comandi meccanici aumentano la versatilità con 3 velocità e PULSE (impulso)**
Mechanical controls add versatility with 3 speeds and PULSE
- **Contenitore in acciaio inossidabile con due maniglie e coperchio gommato**
Stainless steel container with two handles and rubberized lid
- **Nuova base del bicchiere monopezzo lavabile in lavastoviglie per una facile pulizia**
New dishwasher-safe one-piece jar pad for easy cleaning
- **Comandi velocità variabile**
Variable speed controls
- **230 VCA, 50 Hz**
- **Approvato CE**
CE approved





NEW

Mixer a immersione compatto

Light-duty immersion blender	Cod.	L cm*
	5600-WSB35E	17,8



* Lunghezza albero / Shaft length

- **Motore ad alta efficienza a 2 velocità (7.500 e 18.000 giri/min)**
2-speed (7,500 and 18,000 RPM), high-efficiency motor
- **Albero da 17,8 cm fisso**
17.8 cm fixed shaft
- **Leggero e compatto**
Lightweight and compact
- **Lama polivalente in acciaio inossidabile**
All-purpose stainless steel blade
- **11,3 litri di capacità**
11.3-liter capacity
- **120 volt, 60 Hz, 100 W, 0,8 amp**
- **Approvato CE, RoHS**
CE, RoHS approved



Blender immersione standard

Standard immersion blender	Cod.	L cm*
	5600-WSB40E	25,5



* Lunghezza albero / Shaft length

- **Motore da 0,5 CV a 2 velocità (7.500 e 18.000 giri/min) per carichi di lavoro intensi**
½ HP, 2-speed (7,500 and 18,000 RPM), heavy-duty motor
- **Albero da 25,5 cm fisso**
25.5 cm fixed shaft
- **Comoda impugnatura gommata**
Rubberized comfort grip
- **Lama polivalente in acciaio inossidabile**
All-purpose stainless steel blade
- **23 litri di capacità**
23-liter capacity
- **230 volt, 50 Hz, 1,5 amp**
- **Approvato CE, RoHS**
CE, RoHS approved



Attacco frusta per blender alta prestazione

Heavy-duty whisk whipping attachment	Cod.	L cm
	5600-WSB2W	25,5



- **Palette per montare da 25,5 cm in acciaio inossidabile**
25.5-cm stainless steel whipping paddles
- **Si adatta all'intera linea di mixer a immersione Big Stix per carichi di lavoro intensi**
Fits entire Big Stix Heavy-Duty Immersion Blender line
- **Giunto sostituibile dall'utilizzatore**
User-replaceable coupling
- **Ingranaggi pressofusi per prestazioni ottimali**
Die-cast gears for optimal performance
- **Approvato CE, RoHS**
CE, RoHS approved



Mixer bevande a testina singola

Drink mixer,
single spindle

Cod.
5620-WDM120TXE



- **Il motore ad alte prestazioni è sostituibile dall'utente per il funzionamento continuo e include una protezione termica per prolungarne la vita**
Independent, high-performance motor are user-replaceable for continued operation and includes thermal protection to prolong motor life
- **I comandi elettronici a 3 velocità (15.000, 18.000 e 21.000 giri/min) e a impulsi mantengono la velocità sotto carico per prestazioni ottimali**
Electronic 3-speed and pulse controls maintain speed under load for optimal performance - 15,000, 18,000 and 21,000 RPM
- **Gli attuatori completamente chiusi impediscono l'ingresso della miscela nell'alloggiamento**
Fully enclosed actuators prevent mix from entering the housing
- **2 agitatori sulla testina: un agitatore solido per la miscelazione di gelati duri e l'aerazione per una maggiore resa e un agitatore a farfalla per gelati e miscele più morbide**
2 agitators on the spindle: one solid agitator for mixing hard ice creams and aerating for increased yield, and one butterfly agitator for softer ice creams and mix-ins
- **Posizionamento del bicchiere senza doverlo inclinare**
Increased cup clearance: slide cups into position without tilt
- **Funzionamento START/STOP completamente automatico, attivato dalla tazza, con una sola mano**
Fully automatic, cup-activated, one-handed START/STOP operation
- **Resistente, verniciato a polvere, alloggiamento in acciaio pressofuso**
Heavy-duty, powder-coated, die-cast steel housing
- **Bicchiere in acciaio in dotazione da 800 ml**
Stainless steel malt beverage cup (800 ml) included
- **220 VCA, 60 Hz**
- **Approvato CE, RoHS**
CE, RoHS approved



Mixer bevande a testina doppia o tripla

Drink mixer, double
or triple spindle

Cod.
5620-WDM240E
5620-WDM360E

Testina/Spindle
doppia/double
tripla/triple



- **2 motori (WDM240) o 3 motori (WDM360) indipendenti per carichi di lavoro intensi per complessivi 1,3 CV a 3 velocità (16.000, 20.000 e 24.000 giri/min) e impulso**
Two (WDM240) or three (WDM360) independent 1 peak HP motor, three-speed rocker switch (16,000, 20,000 and 24,000 RPM) and PULSE switch
- **Accensione e spegnimento automatico, a velocità impostata, semplicemente inserendo o togliendo il bicchiere dall'alloggiamento**
Fully automatic START/STOP operation.
Motor will run at selected speed once cup is in position
- **Posizionamento del bicchiere senza doverlo inclinare**
Slide cups into position without tilt
- **Struttura in metallo pressofuso adatto ad un uso intenso**
Heavy-duty die-cast housing – easy to clean
- **Agitatore solido di nuova concezione per dare risultati migliori anche con i gelati più duri**
Brand new ultra-aggressive agitator powers through the hardest ice creams
- **Agitatore a farfalla incluso nella confezione, per gelati morbidi e per diverse tipologie di bicchieri**
Also includes butterfly agitator for softer ice creams and use with many types of cups
- **Bicchieri in acciaio in dotazione da 800 ml**
Stainless steel malt beverage cups (800 ml) included
- **Motori con protezione termica.**
Motors incorporate thermal protection
- **Cuscinetto a sfera autolubrificante per un uso intenso e duraturo**
Sealed ball bearings – ball bearings are lubed for life with no need to replace, providing long service life
- **220 VCA, 60 Hz, 110 W, 1,15 amp**
- **Approvato CE, RoHS**
CE, RoHS approved



WDM240E

WDM360E



SISTEMA DI TENUTA LIQUILOCK®
LIQUILOCK® SEAL SYSTEM

**Cutter tagliaverdura 3,8 L
2 CV con espulsore**

3.8 L cutter mixer
and continuous-feed
food processor

Cod. cl
5605-WFP16SCDE 380



- **Sistema di tenuta LiquiLock**
LiquiLock Seal System
- **Alloggiamento pressofuso per carichi di lavoro intensi**
Heavy-duty, die-cast housing
- **Motore commerciale da 2 CV (picco potenza)**
2 HP (peak input) commercial motor
- **Scivolo ad alimentazione continua per lavorazione di grandi volumi**
Continuous-feed chute for large-volume processing

- **La ciotola del mixer con taglierina sigillata da 3,8 L lavora facilmente zuppe, salse, condimenti e altro**
3.8 L sealed cutter mixer bowl processes soups, sauces, dressings and more with ease
- **Oltre 20 opzioni di lavorazione in una sola macchina**
Over 20 processing options in one machine
- **Elaborazione unica della ciotola; sminuzzare, grattugiare e affettare direttamente nella ciotola con il gambo del disco incluso**
Unique batch bowl processing; shred, grate and slice directly in the batch bowl with the included disc stem
- **220-240 VCA, 50-60 Hz, 700 W**
- **Approvato CE, RoHS**
CE, RoHS approved

PIÙ PRODUZIONE IN MENO TEMPO. NESSUN DISORDINE

Il sistema di tenuta LiquiLock® brevettato da Waring consente una maggiore produzione in meno tempo.

Ottieni il massimo dalla capacità della tua ciotola senza alcuna perdita di liquido.

La lama a S si blocca in sede, sigillando il fondo della ciotola, rendendo più sicuro, più pulito e più facile versare le miscele senza che la lama cada nella ciotola degli alimenti lavorati.

La guarnizione rimovibile nel coperchio con chiusura a scatto impedisce al liquido di fuoriuscire dalla parte superiore della ciotola, consentendo di riempirla fino all'orlo.

MORE PRODUCTS. LESS TIME. NO MESS

Waring's patented LiquiLock® Seal System allows for more production in less time. Get the most out of your bowl capacity with bottom- to top-of-the-bowl liquid processing with no leaking.

The patented S-blade locks into place, sealing the bottom of the bowl, making it safer, cleaner, and easier to pour mixtures without the blade falling out into the processed food bowl.

The removable seal in the snap-lock lid prevents any liquid from escaping the top of the bowl.

Fill it to the rim without overflowing.

ACCESSORI INCLUSI CON I MODELLI WFP16
ACCESSORIES INCLUDED WITH WFP16 FOOD PROCESSORS



KIT PER TAGLIO A CUBETTI (10 MM)
10 MM-3/8" DICING KIT
(SOLO CON/ONLY WITH WFP16SCDE)



LAMA A S SIGILLATA E BLOCCATA
SEALED & LOCKED S-BLADE



DISCO PER MONTARE SIGILLATO E BLOCCATO
SEALED & LOCKED WHIPPING DISC



DISCO AFFETTATORE REGOLABILE (1-6 MM)
ADJUSTABLE SLICING DISC (1-6 MM)



DISCO SMINUZZATORE REVERSIBILE (FINE/SPESSE)
REVERSIBLE SHREDDING DISC (FINE/COARSE)

Cutter tagliaverdura da cucina 3,8 L, 0,65 CV

3.8 L cutter mixer
food processor

Cod. cl
5605-WFP16SE 380



- **Sistema di tenuta LiquiLock**
LiquiLock Seal System
- **Alloggiamento pressofuso per carichi di lavoro intensi**
Heavy-duty, die-cast housing
- **Ciotola del miscelatore con taglierina da 3,8 L, praticamente infrangibile e ben visibile con sistema di tenuta LiquiLock® per la lavorazione di liquidi**
3.8 L, virtually unbreakable, clear-view cutter mixer bowl with LiquiLock® Seal System for processing liquids
- **Motore commerciale da 650 W**
650 W commercial motor
- **Pulsanti di controllo grandi e di facile lettura**
Large, easy-to-read control buttons
- **Oltre 20 opzioni di lavorazione in una sola macchina**
Over 20 processing options in one machine
- **Elaborazione unica della ciotola; sminuzzare, grattugiare e affettare direttamente nella ciotola con il gambo del disco incluso**
Unique batch bowl processing; shred, grate and slice directly in the batch bowl with the included disc stem
- **220-240 VCA, 50-60 Hz, 700 W**
- **Approvato CE, RoHS**
CE, RoHS approved





**Cutter tagliaverdura 3,3 L
1 CV con espulsore**

3.3 L cutter mixer and continuous-feed food processor
Cod. 5605-WFP14SCE cl 330



- **Sistema di tenuta LiquiLock**
LiquiLock Seal System
- **Motore da 1 CV ad alte prestazioni**
High-performance 1 HP motor
- **Palette di controllo agevoli, per accensione (ON) e impulso/spengimento (PULSE/OFF)**
Easy ON and PULSE/OFF control paddles
- **Tubo di immissione e spingicibo di grandi dimensioni**
Extra-large feed tube and food pusher
- **Scivolo per immissione continua in policarbonato con maniglie, per preparare grandi volumi**
Continuous-feed rugged black polycarbonate chute for large volume processing
- **Resistente coperchio trasparente**
Durable see-through cover
- **230 VCA, 50 Hz, 2,6 amp**
- **Approvato CE, RoHS**
CE, RoHS approved

Cutter tagliaverdura da cucina 3,3 L, 1 CV

3.3 L cutter mixer food processor
Cod. 5605-WFP14SE cl 330



- **Sistema di tenuta LiquiLock**
LiquiLock Seal System
- **Motore da 1 CV ad alte prestazioni**
High-performance 1 HP motor
- **Palette di controllo agevoli, per accensione (ON) e impulso/spengimento (PULSE/OFF)**
Easy ON and PULSE/OFF control paddles
- **Tubo di immissione e spingicibo di grandi dimensioni**
Extra-large feed tube and food pusher
- **Bicchiere dosatore a tenuta**
Sealed batch bowl
- **230 VCA, 50 Hz, 2,6 amp**
- **Approvato CE, RoHS**
CE, RoHS approved



ACCESSORI INCLUSI CON I MODELLI WFP14
ACCESSORIES INCLUDED WITH WFP14 FOOD PROCESSORS



LAMA A S SIGILLATA E BLOCCATA
SEALED & LOCKED S-BLADE



DISCO PER MONTARE SIGILLATO E BLOCCATO
SEALED & LOCKED WHIPPING DISC



DISCO PER GRATTOGGIARE
GRATING DISC



DISCO AFFETTATORE REGOLABILE (1-6 MM)
ADJUSTABLE SLICING DISC (1-6 MM)



DISCO SMINUZZATORE REVERSIBILE (FINE/SPESSE)
REVERSIBLE SHREDDING DISC (FINE/COARSE)

Cutter tagliaverdura da cucina 1,75 L, 0,75 CV

1.75 L commercial food processor
Cod. 5605-WFP7E cl 175



- **Motore da 0,75 CV ad alte prestazioni per carichi di lavoro intensi**
Heavy-duty ¾ HP high performance motor
- **Bicchiere da lavoro infrangibile e trasparente**
Clear-view unbreakable workbowl
- **Facilità di controllo ON (accensione), OFF (spegnimento) e PULSE (impulso)**
Easy ON/OFF/PULSE control
- **Lama a S seghettata in acciaio inossidabile per trinciare, macinare, miscelare e passare, disco affettatore da 2 mm, disco grattugia sottile e stelo del disco staccabile**
Stainless steel serrated S-blade to chop, grind, mix and purée, disc, fine grating disc, and detachable disc stem
- **Spingicibo di dimensioni piccole e grandi con manicotto di interblocco di sicurezza**
Small and large pushers with safety interlock sleeve
- **230 VCA, 50 Hz, 410 W, 1,8 amp**
- **Approvato CE, RoHS**
CE, RoHS approved



Macina spezie

Commercial spice grinder
Cod. 5660-WSG30E



- **Macina finemente bastoncini di cannella, noce moscata, granelli di pepe nero e molto altro in pochi secondi**
Finely grinds cinnamon sticks, nutmeg, peppercorns and much more in seconds
- **Motore di qualità commerciale a elevate prestazioni 19.000 giri/min.**
High-performance commercial-grade motor - 19,000 Rpm
- **Alloggiamento per carichi di lavoro intensi in acciaio inossidabile opacizzato con coperchio a interblocco di sicurezza**
Heavy-duty brushed stainless steel housing with safety interlock lid
- **Azionamento PULSE (Impulso) per gestire facilmente le dimensioni della macinatura**
PULSE actuation to easily manage consistency of grind
- **In dotazione 3 bicchieri di macinatura completamente rimovibili, lavabile in lavastoviglie in acciaio inox con comodi coperchi per la conservazione**
Includes 3 fully removable and dishwasher-safe stainless steel grinding bowls with convenient storage lids
- **Lame resistenti in acciaio inossidabile**
Durable stainless steel blades
- **230 VCA, 50 Hz, 175 W, 0,76 amp**
- **Approvato CE, RoHS**
CE, RoHS approved



Planetaria

Planetary mixer

Cod.

5605-WSM7LE



- **Trasmissione ad ingranaggi, lubrificazione permanente**
Gear-driven, permanent lube transmission
- **Grande ciotola in acciaio inossidabile da 6,6 L con manico in acciaio inossidabile**
Large, 6.6 L stainless steel bowl with stainless steel handle
- **Controlli frontali e LED luce di alimentazione**
Front-mounted controls and LED power light
- **11 velocità di miscelazione con manopola di controllo della velocità variabile**
11 mixing speeds with variable speed control dial
- **Paraspruzzi rimovibile e trasparente con scivolo di alimentazione**
Removable clear-view splash guard with feed chute
- **Testa inclinabile per una facile rimozione degli accessori e pulizia**
Tilt-back head for easy removal of attachments and cleaning
- **Leva di sollevamento/rilascio per impieghi gravosi**
Heavy-duty head-lift/release lever
- **Protezione da sovraccarico termico**
Thermal overload protection
- **Include ciotola in acciaio inossidabile, frusta da chef, gancio per impastare e pala per mescolare in alluminio**
Includes stainless steel bowl, chef's whisk, dough hook and aluminum mixing paddle
- **Accessori lavabili in lavastoviglie**
Dishwasher-safe accessories
- **Piedini in gomma antiscivolo**
Nonslip rubber feet
- **220-240 V, 50-60 Hz, 350 W**

ACCESSORI INCLUSI CON IL MODELLO WSM7LE
ACCESSORIES INCLUDED WITH WSM7LE PLANETARY MIXER



PALETTA PER MISCELARE
MIXING PADDLE



FRUSTA
CHEF'S WHISK



GANCIOPER IMPASTARE
DOUGH HOOK



CIOTOLA IN ACCIAIO INOX
STAINLESS STEEL BOWL



Affilatore per coltelli

Commercial knife sharpener

Cod.

5665-WKS800E



- **Due mole (grani fini/grossi), una coramella rotante**
Two grinding wheels (fine/coarse) one stropping wheel
- **Mola ad angoli di 18-22°: gli angoli consigliati dai produttori di coltelli**
Grinds at 18-22° angles - optimum angles recommended by knife manufacturers
- **La coramella rotante funziona anche in senso inverso, consentendo un'eliminazione più efficace delle sbavature e la levigatura della lama**
Stropping wheel also operates in reverse direction, allowing for a more efficient removal of burrs and polishing of the blade
- **Un cassetto magnetizzato sotto la mola raccoglie le schegge metalliche rasate**
Magnetized drawer under grinding wheel captures metal shavings
- **230 VCA, 50/60 Hz, 25 W, 0,1 amp**
- **Approvato CE, RoHS**
CE, RoHS approved



Centrifuga in acciaio inox con espulsione della polpa

Heavy-duty pulp eject juice extractor : Cod. **5630-WJX90E**



- **Consigliato per carichi di lavoro intensi in bar, caffetterie, ristoranti, hotel e strutture sanitarie**
Use in high-volume smoothie shops, cafés, bars, restaurants, hotels and healthcare establishments
- **Cestello filtro in acciaio inox e disco tritratore progettati per una resa ottimale e una riduzione degli sprechi**
Stainless steel filter basket and shredder disc designed for a fantastic yield to minimize waste
- **Compatto e leggero**
Compact and lightweight
- **Facile da pulire (tutte le parti sono lavabili in lavastoviglie)**
Easy to clean with all dishwasher-safe parts
- **Ampio scivolo di alimentazione da 8 cm**
Large, 8 cm feed chute for less prep work
- **Grande contenitore per polpa da 11 L**
Large, 11 L pulp container
- **Interblocco di sicurezza**
Includes safety interlock features
- **Beccuccio rotante antigoccia**
Rotating, no-drip spout reduces mess
- **220-240 V, 50-60 Hz, 1000 W**
- **Approvato CE**
CE approved



Centrifuga in acciaio inox

Heavy-duty juice extractor : Cod. **5630-6001X**



- **Trasforma rapidamente frutta e verdura in un ricco succo privo di polpa**
Rapidly converts fruits and vegetables into rich, pulp-free juice
- **La lama ad azione oscillante in acciaio inossidabile velocizza il flusso del succo con una più rapida distribuzione della polpa**
Floating action stainless steel blade speeds up juice flow with faster distribution of pulp
- **Cestello, bicchiere e coperchio di spremitura in acciaio inossidabile**
Stainless steel extraction basket, bowl, and cover
- **Alloggiamento del motore in policarbonato**
Polycarbonate motor housing
- **230 VCA, 50 Hz, 1,4 amp**
- **Approvato CE, RoHS**
CE, RoHS approved



Gelatiera a compressore

Electric ice cream maker : Cod. **5680-WCIC20E** cl 200



- **Il compressore integrato non richiede precongelo**
Built-in compressor means NO pre-freezing required
- **Prepara fino a 2 L di gelato, frozen yogurt o gelato in soli 30 minuti**
Make up to 2 L of ice cream, frozen yogurt or gelato in as little as 30 minutes
- **Esterno in acciaio inossidabile e comandi touch facili da pulire**
Easy-to-clean stainless steel exterior and touch controls
- **La funzione Keep Cool mantiene il gelato alla temperatura ottimale al termine del processo**
Keep Cool feature holds ice cream at the optimal temperature when process is finished
- **220-240 V, 50 Hz, 180 W**
- **Approvato CE, RoHS**
CE, RoHS approved



FACILE AGGIUNTA DEGLI INGREDIENTI SENZA INTERRUPERE IL PROCESSO
MIX-INS COMBINE EASILY WITHOUT INTERRUPTING THE PROCESS



CIOTOLA RIMOVIBILE PER UNA FACILE PULIZIA
REMOVABLE BATCH BOWL FOR EASY CLEANING



WSW16E



WSW25E

Macchina per cottura sottovuoto

Thermal circulator	Cod.	Lt
	5670-WSV16E	16
	5670-WSV25E	25



- **Costruzione interamente in acciaio inossidabile**
All-stainless steel construction
- **5 stazioni di memoria programmabili e timer da 99 ore**
5 programmable memory stations and 99-hour timer
- **Precisione della temperatura di +/- 0,5° C**
Temperature accuracy of +/- 0.5° C
- **Sistema di tubi integrato per rimuovere facilmente e in sicurezza l'acqua dal serbatoio**
Integrated hose system to easily and safely remove water from reservoir
- **Il controllo touch capacitivo consente di impostare o regolare rapidamente la temperatura di cottura**
Capacitive touch control enables you to quickly set or adjust the cooking temperature
- **Intervallo di temperatura da 35°C a 90°C**
Temperature range from 35°C to 90°C (95° F - 194° F)
- **Perfetto per tutti i ristoranti e ideale per il catering**
Perfect for all restaurants and off-premises cooking.
- **220-240 V, 50-60 Hz, 2000 W**
- **Approvato CE, RoHS**
CE, RoHS approved



CONDITE IL CIBO COME DESIDERATE E METTETELO SOTTOVUOTO. I SUCCHI E LE SOSTANZE NUTRITIVE NATURALI VENGONO MANTENUTI DURANTE LA COTTURA

SEASON FOOD WITH YOUR FAVORITE HERBS AND SPICES, THEN VACUUM SEAL NATURAL JUICES AND NUTRIENTS ARE RETAINED WHILE COOKING



POTETE PREPARARE E CUOCERE PIÙ PORZIONI IN ANTICIPO. IL CONTROLLO PRECISO DELLA TEMPERATURA E LA CIRCOLAZIONE CONTINUA DELL'ACQUA, GARANTISCONO UNA COTTURA PERFETTA

PREPARE AND COOK MULTIPLE PORTIONS AHEAD OF TIME. WITH PRECISE TEMPERATURE CONTROL AND CONTINUOUS WATER CIRCULATION, FOOD CANNOT BE UNDER- OR OVERCOOKED



Disidratatore per alimenti

Food dehydrator	Cod.
	5655-WDH10E



- **Creato per chef e mixologist che desiderano aggiungere sapori e consistenze particolari a cibi e bevande**
Built for chefs and mixologists looking to add unique flavor and texture to food and beverages
- **Display a LED digitale con comandi touch capacitivi**
Digital LED display with capacitive touch controls
- **5 stazioni di memoria per l'impostazione e la memorizzazione di programmi personalizzati**
5 memory stations for setting and storing unique programs
- **Intervallo di temperatura regolabile: 0° C - 80° C**
Adjustable temperature range: 0° C - 80° C (32° F - 176° F)
- **Visualizza la temperatura in °C o °F**
View temperature in °C or °F
- **Imposta il timer fino a 99 ore, spegnimento automatico quando il tempo finisce**
Set timer up to 99 hours, automatic shutoff when times lapses
- **10 vassoi di spazio disidratante**
10 trays of dehydrating space
- **Griglia in acciaio inox 38 x 34 cm**
38 x 34 cm stainless steel mesh racks
- **Superficie totale disidratante di 1,3 mq**
Total dehydrating surface area of 1,3 square meters
- **Porta in vetro trasparente per il monitoraggio del processo di disidratazione**
Clear-view glass door for monitoring dehydrating process
- **Sistema di flusso d'aria montato posteriormente**
Rear-mounted airflow system
- **220-240 V, 50-60 Hz, 800 W**
- **Approvato CE, RoHS**
CE, RoHS approved

Grill per panini

Compact Italian-Style panini grill

Cod.

5645-WPG150E

singolo/single

5645-WPG300E

doppio/double



- **Piastre in ghisa rigate per una distribuzione uniforme del calore e un rapido tempo di cottura**
Ribbed cast iron plates for even heat distribution and quick cooking time
- **Superfici di cottura ideali per grigliare panini, hamburger, pollo, verdure e altro**
24 x 23,5 cm (WPG 150E) - 43,25 x 23,5 cm (WPG300E)
Cooking surfaces great for grilled panini, sandwiches, hamburgers, chicken, vegetables and more
24 x 23,5 cm (WPG150E) - 43,25 x 23,5 cm (WPG300E)
- **Corpo in acciaio inossidabile opacizzato e vassoio di gocciolamento rimovibile**
Brushed stainless steel body construction and removable drip tray
- **Piastra superiore incernierata autoequilibrante per accogliere alimenti spessi fino a 7,5 cm**
Hinged, auto-balancing top plate to suit foods up to 7.5 cm thick
- **Termostato regolabile fino a 300°C**
Adjustable thermostat to 300°C (572°F)
- **Spie: Alimentazione e Pronto**
Power ON and Ready indicator lights
- **Maniglie resistenti al calore**
Heat resistant handles
- **230 VCA, 2100 Hz, 8,7 amp (WPG150E)**
230 VCA, 2900 Hz, 12,1 amp (WPG300E)
- **Approvati CE, RoHS**
CE, RoHS approved



WPG150E



WPG300E

Tostapane 4 fette

Medium duty toaster

Cod.

5640-WCT708E



- **Alloggiamento in acciaio al cromo opacizzato**
Brushed chrome steel housing
- **Quattro fessure extralarghe da 3,5 cm per panini**
Four extra-wide 3.5 cm slots, great for bagels
- **225 fette all'ora**
225 slices per hour
- **Comandi per la doratura elettronici**
Electronic browning controls
- **Quattro portafette autocentranti**
Four self-centering bread racks
- **Vassoi per le briciole rimovibili**
Removable crumb trays
- **230 V, 50 Hz, 1800 W, 7,8 amp**
- **Approvato CE, RoHS**
CE, RoHS approved



Piastra per cialde cono (singola o doppia)

Waffle cone maker
(single or double)

Cod.

5655-WWCM180E

Single

5655-WWCM200E

Double



WWCM180E

WWCM200E

- **Alloggiamento pressofuso per carichi di lavoro intensi**
Heavy-duty, die-cast housing
- **Funzione rotante per cottura e doratura uniformi**
Rotary feature for a secure and even bake
- **Le piastre antiaderenti a triplo rivestimento consentono una facile estrazione delle cialde e una rapida pulizia**
Triple-coated, nonstick surface allows for easy removal of waffle cones and minimizes cleanup
- **Tastiera di controllo elettronica facile da pulire**
Easy-to-clean electronic keypad controls
- **Spia luminosa per quando l'apparecchio è pronto e segnalazione acustica per quando la cialda è cotta**
Ready lights and audio chimes signal when unit is ready and when waffle cone is done
- **WWCM180E**
Produce fino a 60 cialde ogni ora
Bakes up to 60 waffle cones per hour
- **WWCM200E**
Produce fino a 120 cialde ogni ora
Il design verticale salva spazio e riduce il consumo energetico
Bakes up to 120 waffle cones per hour
Vertical design maximizes output, using less space and less energy
- **230 VCA, 60 Hz**



ACCESSORIO PER L'AVVOLGIMENTO DELLA CIALDA INCLUSO
INCLUDES A WAFFLE CONE ROLLING AND FORMING TOOL

Pressa per panini gelato

Ice cream sandwich press

Cod.

5680-WICSP180E



- **Alloggiamento pressofuso per carichi di lavoro intensi**
Heavy-duty die-cast housing
- **Le piastre antiaderenti a triplo rivestimento consentono una facile estrazione dei panini e una rapida pulizia**
Triple-coated nonstick plates allow for easy panini removal and quick cleanup
- **Resistenza incorporata per sigillare perfettamente i tuoi panini gelato**
Embedded heating element to perfectly seal your gelato panini
- **Pannello di controllo elettronico dalla facile pulizia**
Electronic control panel for easy cleanup
- **Segnalazioni acustiche quando l'apparecchio è pronto e quando la cialda è cotta**
Audio beep signals when unit is ready and when bun is warmed
- **Tempi di cottura da 5 a 15 secondi per un perfetto panino gelato**
Bake times from 5-15 seconds for the perfect gelato panini
- **Indicatori LED di accensione e pronto per la cottura**
Power ON and Ready-to-Bake LED indicators
- **220-240 V, 50-60 Hz, 1200 W**
- **Approvato CE, RoHS**
CE, RoHS approved

Piastra per waffle (doppia)

Belgian waffle maker (double)

Cod. 5655-WW200E



- **Alloggiamento pressofuso per carichi di lavoro intensi**
Heavy-duty die-cast housing
- **Funzione rotante per cottura e doratura uniformi**
Rotary feature for even baking and browning
- **Le piastre antiaderenti a triplo rivestimento consentono una facile estrazione delle cialde e una rapida pulizia**
Triple-coated nonstick plates allow for easy removal of waffle and quick cleanup
- **Elementi riscaldanti integrati per un controllo esatto della temperatura**
Embedded heating elements for precise temperature control
- **Segnalazioni acustiche quando l'apparecchio è pronto e quando la cialda è cotta**
Audio beep signals when unit is ready and when waffle is cooked
- **Produce fino a 50 waffle alla belga ogni ora**
Produces up to 50 Belgian waffles per hour
- **Nuovo design verticale salvaspazio con luce "Pronto" indipendente**
New space-saving vertical design with independent 'Ready' lights
- **230 VCA, 50 Hz**
- **Approvato CE, RoHS**
CE, RoHS approved



Piastra per mini waffle

Single mini Belgian waffle maker

Cod. 5655-WMB400XCE



- **Alloggiamento pressofuso per carichi di lavoro intensi**
Heavy-duty die-cast housing
- **Funzione rotante per cottura e doratura uniformi**
Rotary feature for even baking and browning
- **Le piastre antiaderenti a triplo rivestimento consentono una facile estrazione delle cialde e una rapida pulizia**
Triple-coated nonstick plates allow for easy removal of waffle and quick cleanup
- **Segnalazioni acustiche quando l'apparecchio è pronto e quando la cialda è cotta**
Audio beep signals when unit is ready and when waffle is cooked
- **Produce fino a 100 mini waffle belgi spessi 2,5 cm e con diametro di 7 cm all'ora**
Produces up to 100, 2,5 cm-thick (1 inch) and 7 cm in diameter mini Belgian waffles per hour
- **Le piastre per waffle possono essere facilmente sostituite se graffiate**
Waffle plates can be easily replaced if scratched
- **Indicatori LED di accensione e pronto per la cottura**
Power ON and Ready-to-Bake LED indicators
- **220-240 V, 50-60 Hz, 1035 W**
- **Approvato CE, RoHS**
CE, RoHS approved



Piastra per bubble waffle

Bubble waffle maker

Cod. 5655-WBW300XCE



- **Alloggiamento pressofuso per carichi di lavoro intensi**
Heavy-duty die-cast housing
- **Funzione rotante per cottura e doratura uniformi**
Rotary feature for even baking and browning
- **Le piastre antiaderenti a triplo rivestimento consentono una facile estrazione delle cialde e una rapida pulizia**
Triple-coated nonstick plates allow for easy removal of waffle and quick cleanup
- **Segnalazioni acustiche quando l'apparecchio è pronto e quando la cialda è cotta**
Audio beep signals when unit is ready and when waffle is cooked
- **Produce fino a 25 bubble waffle all'ora**
Produces up to 25 bubble waffles per hour
- **Una volta cotti i bubble waffle possono essere guarniti con gelato e/o ripieni**
Bake bubble waffles to top with ice cream and/or fillings
- **Le piastre per waffle possono essere facilmente sostituite se graffiate**
Waffle plates can be easily replaced if scratched
- **Indicatori LED di accensione e pronto per la cottura**
Power ON and Ready-to-Bake LED indicators
- **220-240 V, 50-60 Hz, 1035 W**
- **Approvato CE, RoHS**
CE, RoHS approved



WAFFLE 21 x 18 cm
30 BUBBLES

INDICE PRODOTTI

INDEX OF PRODUCTS

Affettapane	67	Fruste	62	Rotella taglia pizza	59-111-121-149
Affilacoltelli manuale	74	Ganci macelleria	64	Rullo bucasfoglia	122
Affilacoltelli elettrico	192	Gastronorm inox	78-79	Saccapoche	116-118
Agitatore	159	Gastronorm in plastica	82	Sbuccia arancia	63-155
Alare per forno	105	Gastronorm polipropilene	83	Sbucciaverdure	63
Alzate per dolci	132-134	Gelatiere a compressore	193	Scaldapasta	47
Appendipale da parete	104	Grattugie	60-62-67-149	Scavini	63-155
Apribottiglie	160-174	Griglia inox	127-133	Schiumarole	52-54-56
Arriccias burro	63	Griglia per decorazione	133	Scolapasta	49
Assi pizzeria	93	Grill per panini	195	Secchielli vino	175
Bacchette	149	Guanti forno	62	Secchiello ghiaccio	174
Bacinelle gelato	23	Jiggers	159-166-167	Separatore per GN	80
Bacinelle	49	Lame per mandolina	67	Servizi per olio, aceto, sale, pepe	148
Bagnomaria	48	Lattiera	158	Sessole	126-168-174
Barra ordinazioni	177	Levatosolo	63	Setacci	49
Base per bacchette	149	Macchina per cottura sottovuoto	194	Set intaglio e decorazione	74-155
Batticarne	64	Macinaspezie elettrico	191	Shaker	164-165
Bicchieri	164-183	Mandoline	67	Sifoni	177
Bicchieri per boston shaker	163	Maniglie cascanti per GN	80	Sottobicchieri e sottobottiglia	160
Blender	188	Mestolini per ciliegie	158	Spalmaburro	140-142
Bocchette per decorazione	117→119	Mestolini per salsa	140-145	Spargicacao	158
Bordatore di bicchieri	180	Mestoli	52-54-56-140	Spatole	55-58-109-110-120-121-132
Borsa da viaggio pizaiolo	97	Misurini	48-127	Spazzole pizzeria	95
Boston shaker	162	Mixer	188→189	Spazzolone pizzeria smontabile	96
B-Pour tester dosaggi	28-153	Mixing glasses	164	Spazzoloni pizzeria	94-95-99-101-102
Cannucce	184	Molle	12→17-32-114-142-152	Spatole per gelato	22
Cappelli cuoco	127	"Mollunghe"	13	Speed bottle	79
Caraffa	183	Morsa prosciutto base in legno	65	Speed racks	177
Carrello per mandolina	67	Mugs	170-171	Spicchio per casseruola	47
Casseruole alte	34-36-38-42-44	Oliera pizzeria	105	Spiedini inox	65
Casseruole basse	34-36-38-42	Padelle	35-36-39-43-44	Spremiagrammi manuale	158
Casseruola bassa antiaderente	40	Padelle antiaderenti	35-37-40-43	Spremilimone	160-173
Casseruole bombate	35-37-43	Pala braci	93-101	Spumantiera	175
Casseruole medie	34-36-38-42-44	Pale e paletti pizzeria	88→93-98→103	Stampi pasticceria	128→131-134
Casseruole medie antiaderenti	40	Pala e palettino pizzeria smontabili	96	Stampi semifreddo	127
Centrifuga	193	Pale e paletti pizzeria Gluten Free	100	Steady Spout	29-154
Cestelli lavastoviglie	76-77	Pale pasticceria e gastronomia	139→141-144	Tagliabiscotti	123→126
Cestini	185	Palette	52-54-57-59-110	Tagliapasta	58-110-121-122→125
Chinois	47	Pennelli pasticceria	122	Tagliatartufi	149
Colini	30	Pentole	35-36-39	Taglieri	75-181
Colino per cocktail	159-163	Pestelli	168	Tappeti bar	181
Colonne per secchiello	175	Pettine per decorazione pasticceria	132	Tappi versatori	24→29-152→154
Coltelli cucina	68→74	Piastra per cialde cono	196	Tazzoni	48
Coltelli tavola	138→142	Piastre per waffle	197	Tegami	35-37-39-43-44
Contentore palline pasta per pizza	105	Piatti espositori	66	Tegame antiaderente	40
Coperchi pentolame	35-36-39-43-44	Pinze	14-15-115	Teglie	50-51-106-107
Coperchi gastronorm	80-82-83	Placca per forno	50-106	Teglia Gastronorm	79
Cucchiaini miscelatori	169	Planetaria	192	Timballo per dolci	48
Cucchiaini	138→141	Poggiaavasoio	184	Tirabrai	95-101
Cucchiaini bibita	140-145-155-159	Portacondimenti	176	Tortiere	51-107-128-130-131
Cucchiaini	52-54-56-57-105-140-141-145	Portacucchiaini	159	Tostapane	195
Cucchiaini tavola	138→142	Portapale	104	Tronchetto tagliapizza	59-111
Cuocithé	160	Portaoggetti da bar	180	Vaporizzatori cocktail	173
Cutter tagliaverdure	190-191	Portastecchi	148	Vaschetta lavaggio dosatori gelato	159
Dash bottles	173	Portatovaglioli	160-176-184	Vassoi	146-147-156-157
Decora limone	63-155	Portavivande	66	Versus	178-179
Disidratatore alimenti	194	Portazucchero	184	Wok antiaderente	35-37
Dispenser in polietilene	183	Porzionatori gelato	20-21		
Falso fondo forato per GN	80-82-83	Posacenere	182		
Fermo per taglieri	75	Posate insalata	140-145		
Flair bottle	182	Pressa per panini gelato	196		
Forbici taglia pizza	111-149	Raccoglibriciole	177		
Forchetta per ostrica	145	Raschie	59-110-122		
Forchetta scavino per aragosta	145	Rete protettiva per bar	181		
Forchette tavola	138→142	Riga limone	63-155		
Forchettina per lumache	145	Robot da cucina	190-191		
Forchettoni	52-54-56-140-141	Rompighiaccio manuale	168		
Formaggiera in filo	148	Rompighiaccio elettrico	168		
Friggitrice doppia	195	Rostiera rettangolare alta	38		
Frullatori	186-187	Rotella taglia pasta	122		

Adaptor bar for GN	80	Graduated bucket	51	Pizza wheel cutters	59-111-121-149
All-purpose scoop	126-168-174	Graters	60-62-67-149	Pizzeria brushes	100-101
Apple corer	63	Ham vice	65	Pizzeria oil cruet	105
Ashtrays	173-187-193	Hand held knife sharpener	74	Planetary mixer	192
Bain marie pot	48	Hats	127	Plastic box for dough	103
Baking tray	50-51-106-107	Heating liquid for chafing dish	157	Plastic cruets	187
Baking plate	50-106	Ice-breaker - electric	168	Plastic grill for decorated biscuit	133
Bar mats	181	Ice-breaker - manual	168	Polyethylene dispenser	183
Bar organizer	180	Ice bucket	174	Pourers	24→29-152→154
Baskets	185	Ice-cream container	23	Protection mesh for bar	181
Belgian waffle makers	197	Ice-cream sandwich press	196	Removable pizza peel and turning peel	96
Beverage spoons	140-145-155-159	Ice-cream scoop	20-21	Removable rotatable oven brush	96
Biscuit cutter	123→126	Ice-cream server	22	Roaster	38
Blades for vegetable slicer	67	Jiggers	159-166-167	Roller cutter	122
Blenders	186→188	Juice extractors	193	Safety guard	67
Boston shakers	162	Kitchen bowl	48	Salad servers	140-145
Bottle-openers	160-174	Knife sharpener	192	Sauce ladle	140-145
Bowl	49	Knives	68→74	Scissor servers	14-15-115
B-Pour pour check	28-153	Ladles	52-54-56-140	Scrapers	59-110-122
Bread cutter	67	Large spoon	52-54-56-57-105-140-141-145	Semifreddo moulds	127
Butchery hooks	64	Lemon decorator	63-155	Shakers	164-165
Butter curler	63	Lemon grater	63-155	Shallow cookpots	34-36-38-40-42
Butter spreader	140-142	Lemon squeezer	160-173	Shallow saucepan	34
Cake mould	128→131-134	Lids for pots and pans	35-36-39-43-44	Sieves	49
Cake stand	132-134	Lid for gastronorm	80-82-83	Skewers	65
Carafe	183	Lifters	52-54-57-59-110	Skimmers	52-54-56
Carving and decoration set	77-165	Lobster pick	145	Snail fork	145
Champagne bowl	175	Long handle strainer	61	Spatulas	55-58-109-110-120-121-132
Charcoal shovel	93-101	Measuring jug	48-127	Speed bottle	179
Cherry ladles	158	Meat beater	64	Speed racks	177
Chinois	47	Meat fork	52-54-56-140-141	Spice grinder	191
Chopsticks	149	Medium cookpots	34-36-38-40-42	Spirits measure	190
Chopstick rest	149	Medium saucepans	34-36-38-40-42	Stand for bucket	185
Citrus fruit squeezer - manual	158	Melon baller	63-155	Steady Spout	29-154
Coaster	160	Milk jug	158	Stirring spoon	159
Cocktail atomizer	173	Mixers	188→189	Stopper for cutting boards	75
Cocktail strainer	159-163	Mixing glasses	164	Strainer for deep cookpot	47
Cocoa sprinkler	158	Mixing spoon	169	Strainers	30
Compact panini grill	203	Moka spoon	138→141	Straws	184
Condiment set	148	Moka spoon holder	159	Sugar bowl	184
Cruets	176	"Mollunga" tongs	13	Syphons	177
Crumb sweepers	187	Mugs	180-181	Vegetable peeler	67
Curved saute pans	35-37-43	Napkin-holder	160-176-184	Table fork	138→142
Cutting boards	75-181	Nozzles brush	117	Table knife	138→142
Dash bottles	173	Orange peeler	63-155	Table spoon	138→142
Decorating nozzles	117→119	Order rack	177	Tea infuser	160
Deep cookpots	34-36-38-42-44	Oven brushes	94-95-99-101-102	Thermal circulator	194
Deep fryer	195	Oven rake	95-101	Toaster	195
Deep saucepans	34-36-39-40-42	Oyster fork	145	Tongs	12→17-32-114-142-152
Dishwasher racks	76-77	Panini grill	195	Toothpicks holder	148
Display tray	66	Pans	35-36-39	Trays	146-147-156-157
Electric ice-cream maker	193	Parmesan cheese cellar	148	Tray rest	184
Falling handles for GN	80	Pasta strainer	49	Truffle-slicer	149
Firedog	105	Pasta warmer	47	Two-handed frying pans	35-37-39-40-43-44
Flair bottle	182	Pastry bags	116-118	Vegetable dish	152
Flat rack	127-133	Pastry brushes	122	Vegetable slicer	63
Flexible desk cleaner	104	Pastry comb for decoration	132	Versus	178-179
Food carrier	66	Pastry cutter	58-110-121-122→125	Waffle cone maker	196
Food dehydrator	194	Pastry moulds	127→136-141	Wall mounted peel rack	103
Food processors	190-191	Pastry wheel cutter	120	Whisks	62
Frying pans	35-36-39-40-43-44	Peel holder	104	Wine buckets	175
Gastronorm baking pan	79	Pestles	168	Wok with non-stick coating	35-37
Gastronorm drainer plate	80-82-83	Pie mould	48		
Gastronorm in plastic	82	Pie servers	139→141-144		
Gastronorm in polypropylene	83	Pizza boards	93		
Gastronorm in stainless steel	78-79	Pizza chef travel bag	97		
Glasses	164-183	Pizza cutter	59-111		
Glass for boston shaker	163	Pizza peels and turning peels	88→93-98→103		
Glass rimmer	180	Pizza peels and turning peels Gluten Free	100		
Gloves	62	Pizza scissors	111-149		

TABELLE CONVERSIONE

CONVERSION TABLES

LUNGHEZZA LENGTH

0,30	1	3.28
0,61	2	6.56
0,91	3	9.84
1,22	4	13.12
2,52	5	16.40
1,83	6	19.68
2,13	7	22.96
2,44	8	26.25
2,74	9	29.53
3,05	10	32.81
6,10	20	65.62
15,24	50	164.05
30,50	100	328.10

METRI
METERS

PIEDI
FEET

2,54	1	0.39
5,08	2	0.79
7,62	3	1.18
10,16	4	1.58
12,70	5	1.97
15,24	6	2.36
17,78	7	2.80
20,32	8	3.16
22,86	9	3.55
25,40	10	3.94
50,80	20	7.88
127,00	50	19.70
254,00	100	39.40

CENTIMETRI
CENTIMETERS

POLLICI
INCHES

PESO WEIGHT

28,3	1	0.04
56,7	2	0.07
85,0	3	0.10
113,4	4	0.14
141,8	5	0.18
170,1	6	0.21
198,4	7	0.25
226,8	8	0.28
255,2	9	0.32
283,5	10	0.35
567,0	20	0.71
1417,5	50	1.76
2835,0	100	3.53

GRAMMI
GRAMS

ONCE
OUNCES

0,45	1	2.21
0,91	2	4.41
1,36	3	6.62
1,81	4	8.82
2,27	5	11.02
2,72	6	13.23
3,18	7	15.43
3,63	8	17.64
4,09	9	19.84
4,54	10	22.05
9,07	20	44.09
22,68	50	110.20
45,36	100	220.50

CHILOGRAMMI
KILOGRAMS

LIBBRE
POUNDS

CAPACITÀ CAPACITY

3,79	1	0.26
7,57	2	0.53
11,35	3	0.79
15,14	4	1.06
18,93	5	1.32
22,71	6	1.58
26,50	7	1.85
30,28	8	2.11
34,16	9	2.38
37,94	10	2.64
75,88	20	5.28
189,70	50	13.20
379,40	100	26.40

LITRI
LITERS

GALLONI USA
USA GALS

1,50	0,5	0.16
2,25	0,75	0.25
3,00	1	0.33
4,50	1,5	0.50
6,00	2	0.66
7,50	2,5	0.83
9,00	3	1.00
10,50	3,5	1.16
12,00	4	1.33
13,50	4,5	1.50
15,00	5	1.66
16,50	5,5	1.83
18,00	6	2.00

CENTILITRI
CENTILITERS

ONCE
OZS

TEMPERATURA TEMPERATURE

-40,0	-40	-40.0
-28,8	-20	-4.0
-23,3	-10	+14.0
-17,7	0	+32.0
-12,2	10	+50.0
-6,6	20	+68.0
+2,7	37	+98.6
+4,4	40	+104.0
+10,0	50	+122.0
+37,7	100	+212.0

CELSIUS

FAHRENHEIT